

USER GUIDE

DRAG BOX

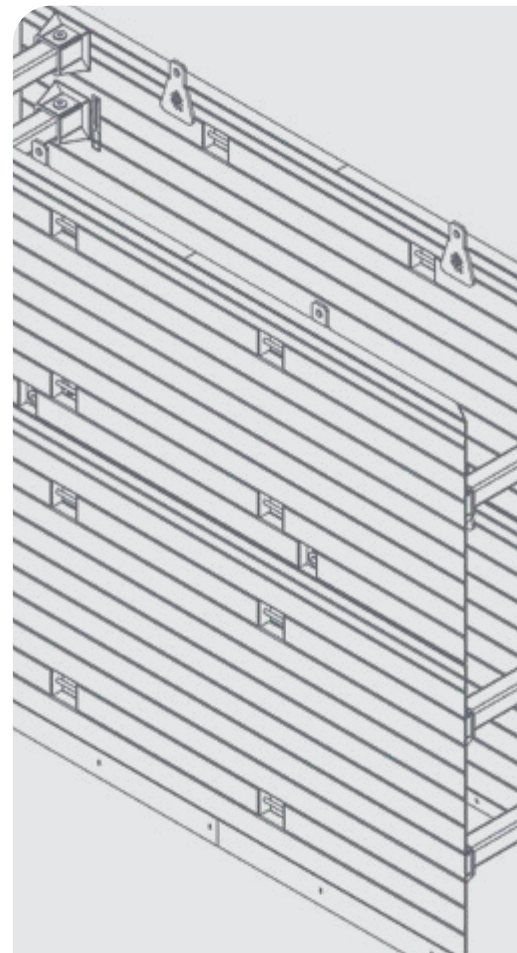

DISCLAIMER

Conquip Engineering Group have prepared this document to provide guidance on the safe erection, use and dismantling of the product it relates to. Conquip Engineering Group is committed to ensuring our customers are informed and supported throughout the use of our equipment. This document does not relieve users of their own duty of care.

This user guide is based on the user being familiar with this type of equipment, exercising all reasonable skill and care in its use. All work with the equipment should only be undertaken with suitably competent and supervised operatives.

The user should take into account this user-guide, as well as all other available documentation and guidance provided by Conquip and the wider construction industry. The user must remain compliant with relevant safety laws and industry good-practice. Considerations for a Safe System of Work should include, but are not limited to:

Safe handling and lifting of equipment

Provision of safe access and prevention of falls from height

Identification of buried services and unexploded ordinance

Working within confined spaces

Inspection and suitability of ground conditions for the equipment selected

Your attention is drawing to the Construction Design Management Regulations 2015 whereby the person selecting a product for use is a designer and must take account of the health and safety issues arising from their use.

Conquip Engineering Group does not accept any responsibility for the user's operation of the equipment.

Conquip Engineering Group operate a continuous improvement policy and therefore may change the contents of this document at any time without notice.

Your statutory rights are unaffected

If in doubt, ask Conquip Engineering Group for assistance.

CONTENTS

PRODUCT INFORMATION

INTRODUCTION	04
SPECIFICATION	05
COMPONENTS	06

USAGE INSTRUCTIONS

IMPORTANT USAGE NOTES	08
ASSEMBLY INSTRUCTIONS	08
INSTALLATION INSTRUCTIONS	10
USE, INSPECTION & MAINTENANCE	12
OPERATIONAL PROCEDURES	12
EXTRACTION INSTRUCTIONS	15

MAINTENANCE & INSPECTION

MAINTENANCE REGIME	16
VISUAL INSPECTION SHEET	17

SAFETY

SAFETY INSTRUCTIONS	18
USAGE AND TRANSPORT	19
PERSONNEL	20
DO'S & DON'TS	21

LEGAL

TERMS AND CONDITIONS	22
EC DESIGN CONFORMITY	26
STANDARDS AND REGULATIONS APPLICABLE	27

INTRODUCTION

OVERVIEW

The Conquip [Drag Box](#) is a simple to assemble, edge-supported trench lining system installed into open-cut trenches. Trenches are cut in advance of the box, and the box is dragged through as work progresses.

They are designed to only be used in ground that is self-supporting for the short duration the box is being used. The ground should be cut or benched back such that it isn't loading the box walls, as such loads would inhibit the ability to drag the box through the ground due to friction being generated on the sides.

Drag boxes are therefore designed to act as 'shields' only, to protect the workforce in the event of unexpected ground movements. They should not be used where ground retention and limiting movements are important. Therefore, it is important that site-specific risk assessments and inspection of ground conditions are carried out to ensure the ground is suitable.

Despite their intended use as shields, drag boxes are still able to provide structural support to earth pressures, should the trench walls collapse. Safe Working Loads are provided with technical performance of the boxes.

Conquip Drag boxes come in 5.0 and 7.1m lengths. Fixed internal struts are available for internal working widths of 0.6 to 3.0m. There is also a 'hog back' strut available for additional height clearance.

Manufactured in the UK from quality British and EU steel. Conquip also supply a full range of suitable lifting and extraction chains, edge protection and trench access accessories.

SPECIFICATION

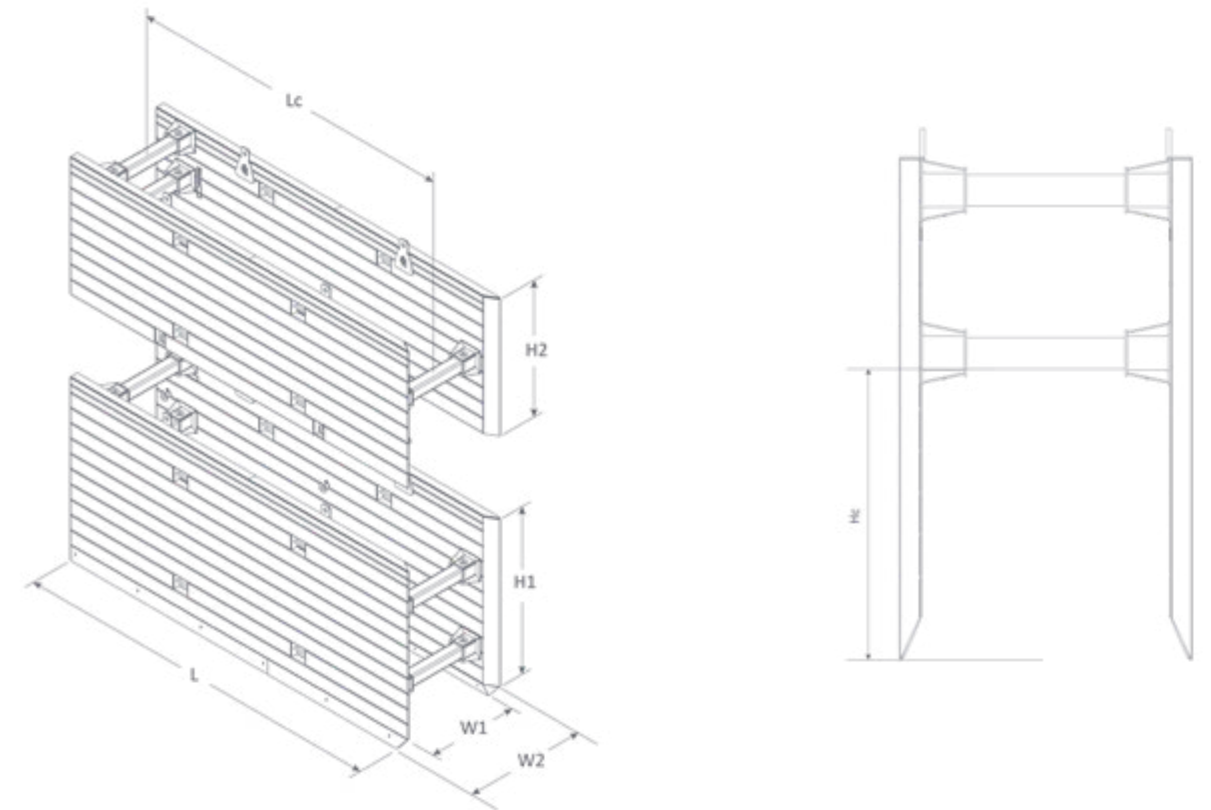

		5000 BOX		7000 BOX	
		MIN	MAX	MIN	MAX
BASE	ASSEMBLED WEIGHT (kg)	3600	4015	5120	5535
	HEIGHT (mm)	H1	2410		
EXTENSION	ASSEMBLED WEIGHT (kg)	2475	2785	3845	4285
	HEIGHT (mm)	H2	1810		
	LENGTH (mm)	L	5110	7110	
	SWL BOX PANEL PRESSURE (kPa)		30	20	
STANDARD STRUT	INTERNAL WIDTH (mm)	W1	700-3000		
	EXTERNAL WIDTH (mm)	W2	900-3200		
	CLEARANCE BELOW STRUT (mm)	Hc	1400		
	CLEARANCE BETWEEN STRUTS (mm)	Lc	4140	6140	
HOG BACK STRUT	INTERNAL WIDTH (mm)	W1, hog	2190		
	EXTERNAL WIDTH (mm)	W2, hog	2390		
	CLEARANCE BELOW STRUT (mm)	Hhog	1750		

COMPONENTS

BOXES



5.0m Base Panel

5.0m Extension Panel

25mm Dia pin with R clip

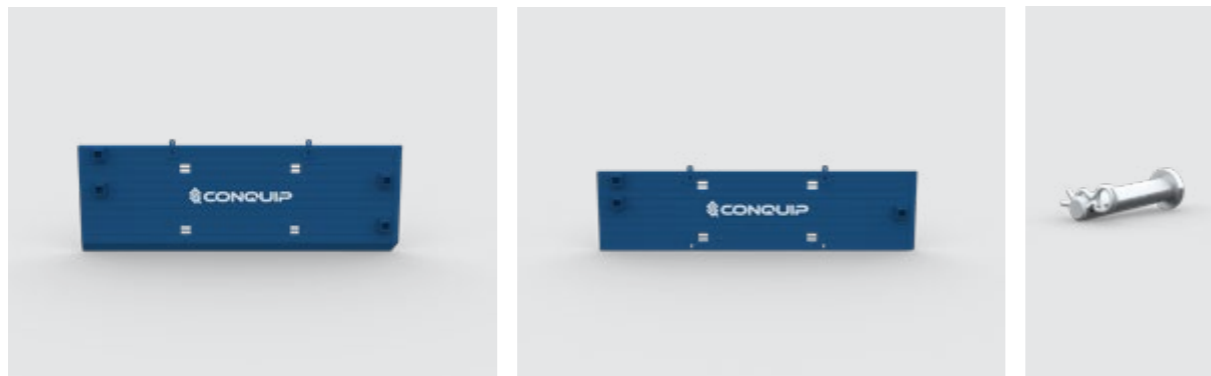

7.0m Base Panel

7.0m Extension Panel

25mm Dia pin with R clip

ITEM CODE	ITEM	WEIGHT (Kg)
TL900032	5.0m Base Panel (Left)	1750
TL900033	5.0m Base Panel (Right)	1750
TL900037	5.0m Extension Panel (Left)	1200
TL900038	5.0m Extension Panel (Right)	1200
TL900137	7.0m Base Panel (Left)	2510
TL900138	7.0m Base Panel (Right)	2510
TL900139	7.0m Extension Panel (Left)	1885
TL900140	7.0m Extension Panel (Right)	1885
TL900036	25mm Dia pin with R Clip (For struts)	2
TL900039	25mm Dia pin with R Clip (For extensions)	1

COMPONENTS

STRUTS

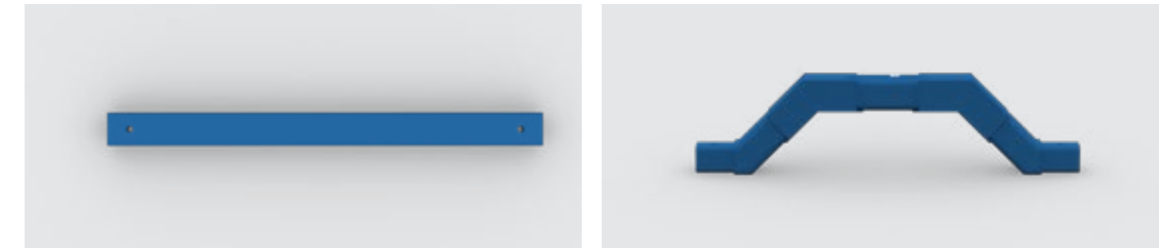

Standard Strut

Hog Back Strut

ITEM CODE	ITEM	WEIGHT (kg)
TL900048	580mm Standard Strut	25
TL900153	680mm Standard Strut	29
TL900049	780mm Standard Strut	34
TL900295	855mm Standard Strut	36
TL900292	880mm Standard Strut	37
TL900050	980mm Standard Strut	42
TL900311	1080mm Standard Strut	46
TL900035	1180mm Standard Strut	50
TL900284	1280mm Standard Strut	55
TL900051	1380mm Standard Strut	59
TL900296	1480mm Standard Strut	63
TL900052	1580mm Standard Strut	68
TL900053	1780mm Standard Strut	77
TL900286	1880mm Standard Strut	80
TL900054	1980mm Standard Strut	85
TL900285	2080mm Standard Strut	89
TL900055	2180mm Standard Strut	94
TL900056	2380mm Standard Strut	103
TL900057	2580mm Standard Strut	111
TL900058	2780mm Standard Strut	120
TL900059	2980mm Standard Strut	128
TL900331	2180mm Hog Back Strut	191

USAGE INSTRUCTIONS

IMPORTANT USAGE NOTES

- Top extension boxes are to be assembled in the same way but only two struts should be fitted.
- Extension boxes are secured to the base boxes using connector brackets and pins.
- Keep hands clear of pinch points.

ASSEMBLY INSTRUCTIONS

01. Before assembling Conquip base boxes and extension boxes, lay timber bearers on the ground.
02. Attach a certified 4 leg chain sling to the four handling points of a side panel and lower onto the timber bearers with the flat face down.



03. Place struts of equal lengths into the connection points protruding from the panel, secure using 25mm pins and R-clips.

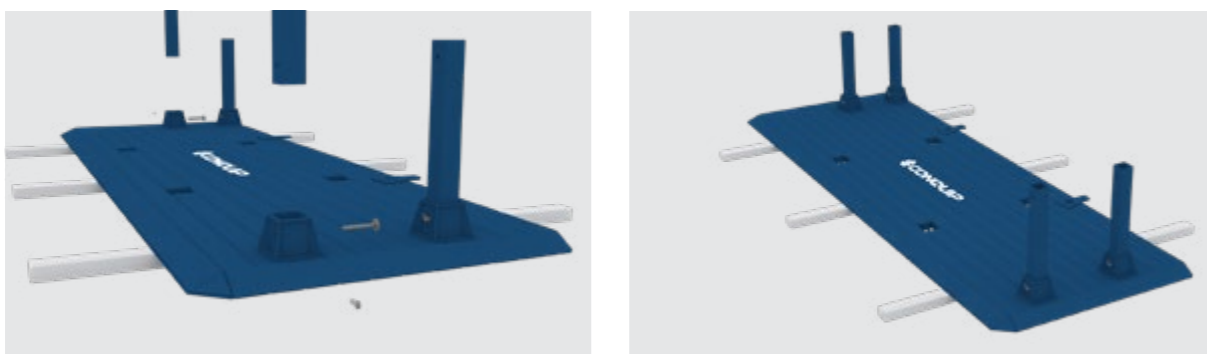

04. Connect the sling to the four handling points of the opposite base side panel (flat face up) and lower into position above the struts.
Do not detach the chains until the panel is secured to the strut assemblies.



05. Secure the struts to the panel with the remaining 25mm pins and R-clips.
06. Connect a 4 leg chain to the lifting points on the top assembly.
07. Lift into its working position.



08. The box is assembled and ready to move into the trench.

IMPORTANT INSTALLATION NOTES

In all cases you must ensure:

- All buried services and U.X.Os (Unexploded Ordnance) have been identified prior to works and will not be impacted by the excavation unless accounted for in the design.
- Safe Systems of Work are being worked to at all times.
- Provide safe means of access for assembly and inspection.

INSTALLATION INSTRUCTIONS

INSTALLING BASE BOXES

01. Excavate an initial length of trench, slightly wider than the external box dimensions.

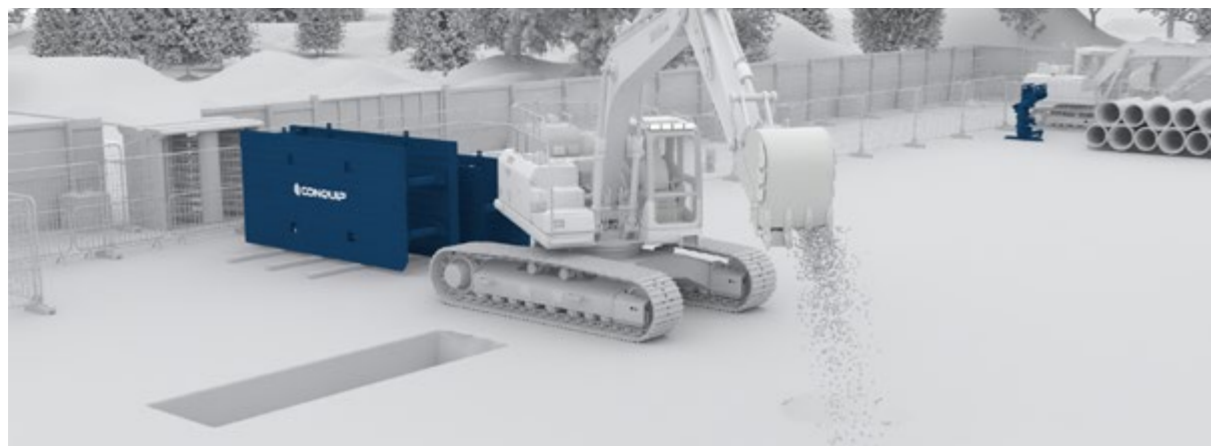

02. Lift the base box into the trench using an excavator or crane. Allow for at least 100mm projection above the top of the box.



03. The Drag Box must NOT be pushed down into the trench.

04. Ensure the box is installed vertically.

INSTALLING EXTENSION BOXES

01. Place the base box upright in a partially dug trench, approximately 1.0m deep.

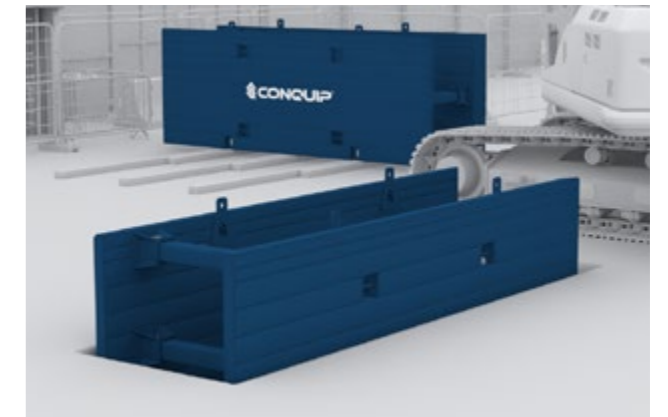
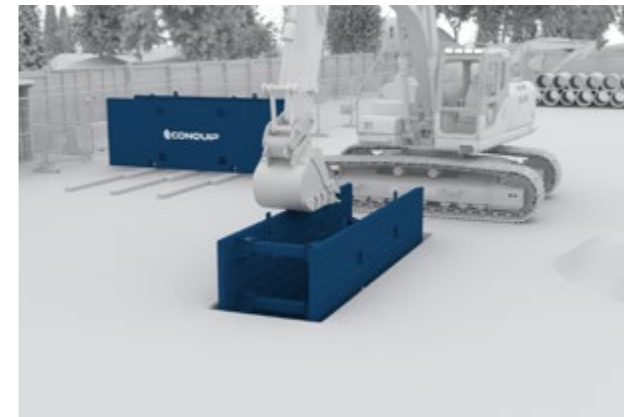

02. Assemble the extension box using the same instructions as the base box assembly.

03. Lift the extension box onto the base box. Do not detach the chains until the extension box is secured.

04. Connect using 25mm pins and R-clips.

05. Lift the full assembly from the trench, excavate to the full depth and lift the assembled box back into the trench.

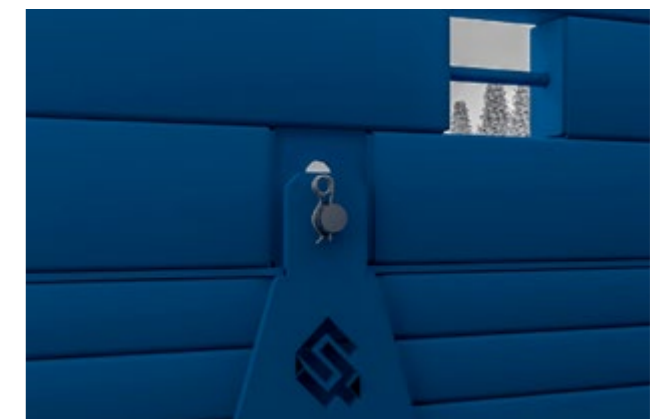

USE, INSPECTION & MAINTENANCE

Prior to entering the excavation:

- Check the box and access equipment have been installed correctly. A suitably competent person should inspect the excavation from the top. Carry out air monitoring and testing as appropriate.
- Contractor must provide operatives with suitable training and briefings to safely carry out works within the excavation.
- Contractor must ensure activities surrounding the excavation are not detrimental to the integrity of the excavation (e.g. surcharges or adjacent digging that have not been considered as part of the original excavation design).
- Never move a Drag Box whilst operatives are inside.
- Before first use and at the start of each working shift, a competent person must inspect the excavation, surrounding ground, equipment, edge protection and air quality (if required), to ensure all are satisfactory.

OPERATIONAL PROCEDURES

01. Suitable Conquip Edge Protection must be installed if the top of the Drag Box protrudes less than 1m from ground level.

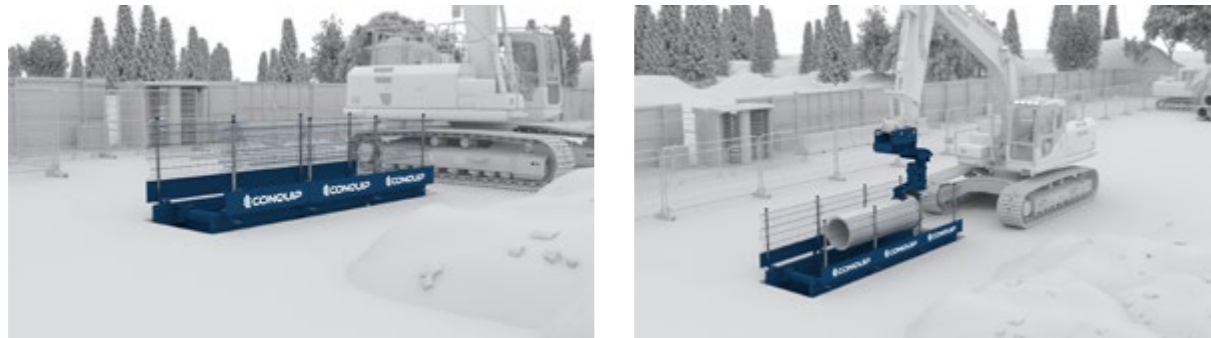

02. Lower the pipe into the Drag Box with the aid of a banksman ensuring all personnel are clear of the operation.



03. As work progresses, the operator digs ahead of the box.

04. **OPTION 01:** For strut assemblies up 1180mm in length, hook the excavator bucket around the top strut and gently lift and drag the box.

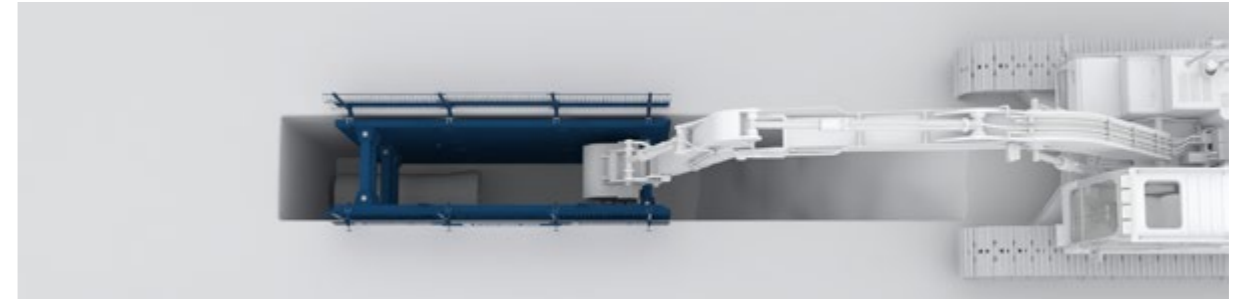

05. **OPTION 02:** For struts longer than 1180mm, or if the sides of the excavation have slumped against the side panels, drag by attaching a suitably rated four leg chain to the base box lifting points.

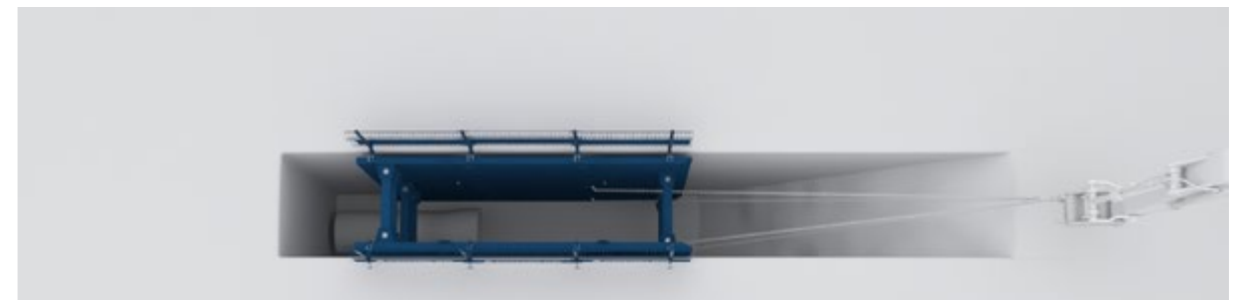

06. Backfill onto the pipes at the rear of the Drag Box.

07. Lower the next pipe into the Drag Box.

08. Our Excavator Mechanical Pipe Lifter allows for accurate pipe placement.



09. Our Excavator Compaction Wheel can be used to compact the surface after the Drag Box has moved.

10. Repeat steps 03 to 09 until all pipes have laid.

EXTRACTION INSTRUCTIONS

01. Once all pipes have been laid and back filled, the Drag Box can be removed. Attach a suitably rated single leg chain to one of the top lifting points of the extension box, then slowly lift to loosen the ground.



02. Repeat this process for the other top lifting points until the Drag Box is ready to extract and detach single leg chain.

03. Attach a suitably rated 4 leg chain to the top lifting points of the extension box and extract the entire box.

04. Backfill the trench as soon as possible after the box is removed. To compact the surface area, use our Excavator Compaction Wheel.



STORAGE INSTRUCTIONS

01. Remove the R-clips and the pins to disconnect the extension box from the base box.

02. Attach a four leg chain to the top lifting points of the extension box.

03. Lift the extension box up and onto timber bearers, then lower it onto its side to prevent wind loading.



04. Attach a suitably rated 4 leg chain sling to the top lifting points of the base box.

05. Lift the base box and place it on timber bearers, then lower it onto its side.

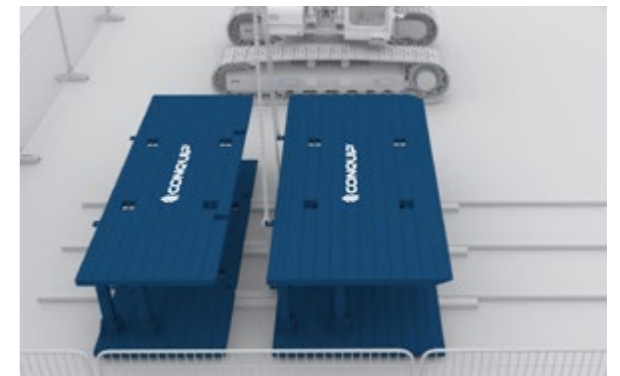

06. Once the boxes are safely stored and the surface area has been sufficiently compacted, remove all equipment from the area.

MAINTENANCE & INSPECTION

MAINTENANCE REGIME

- It is mandatory that the equipment is thoroughly examined regularly, by a qualified engineer, to ensure compliance with relevant regulations. Conquip recommend carrying out a thorough examination every six months.
- This equipment may incorporate various loose and detachable items including, but not limited to pins, bolt assemblies and adaption plates. Refer to the separate requirements for the safe use of those items.
- This equipment must be inspected by the responsible person before each use and then regularly, as determined by your risk assessment or working practice. If you have any concerns about the equipment's condition or suitability, do not use it.

VISUAL INSPECTION CHECKLIST

INSPECTION ITEMS	RESULTS		COMMENTS
	SATISFACTORY	UNSATISFACTORY	
Serial Number			CQ.....
Product Code			
Working Load Limit (kg)			
Conforms to user guide specification			
Lift points bent or worn			
Rocker pins fitted / secured with R clip			
Strut pins fitted / secured with R clip			
Strut adjustment pins secured with R clip			
Extension box connector bracket fitted			
Extension box connecting pins secured with R clip			
General visual body inspection			
SIGNATURE			
Name	Position	Qualification	Signature & Date

SAFETY INSTRUCTIONS

BASIC SAFETY NOTES

A site-specific Risk Assessment, and lift plan where applicable, must be completed by the responsible person before using this equipment to control risks, produce a safe system of work and ensure safety for you, your colleagues and others. Your risk assessment will determine the correct Personal Protective Equipment (PPE) for the task you are doing.



M002
Refer to instructions manual



M004
Wear eye protection



M008
Wear safety footwear



M009
Wear protective gloves



M010
Wear protective clothing



M014
Wear head protection



M015
Wear high-visibility clothing

IMPORTANT SAFETY NOTES

Read these instructions before using this equipment. If there is anything you do not understand or if you have any concerns do not use this equipment. Contact your supervisor or Conquip Engineering Group for advice.

- You must check that you have considered all the safety requirements for the task you are doing and that this equipment is suitable.
- You must protect bystanders and the general public by preventing access to the working area.
- Do not use this equipment if you are tired, unwell or under the influence of alcohol or drugs. If you are taking any medicine or undergoing treatment you should inform your supervisor.

USAGE & TRANSPORTATION

- Never unevenly load this equipment.
- The weight of the equipment, together with its attachments, must be added to the weight of the load when calculating the total load that will be imposed on the lifting apparatus / operating machine.
- This equipment must be used in conjunction with the load ratings of the lifting apparatus / operating machine. (Refer to the manufacturers' load ratings and original working instructions).
- Make sure you know how to use this equipment and understand all aspects of its operation in case of emergency.
- This equipment weighs more than 25kg. Do not lift or manhandle without machine assistance.
- Do not operate this equipment near overhead power lines.
- Take care in confined spaces, near ceilings or similar hazards. This equipment was designed for vertical lifting. Do not drag, or swing.
- Before operating this equipment, check that you have enough space for you to work safely and make sure that the working area is clear of hazards, obstructions and personnel.
- Before lowering equipment make sure that the landing zone is clear and capable of accepting the size and weight of the load.
- Crush Risk. Keep hands and feet clear of the equipment at all times to avoid injury.
- Do not exceed the maximum Working Load Limit (WLL) shown on the serial plate.

- Ensure that the WLL on the individual lift points is not exceeded.
- Before lifting, check that the load is secured, balanced and stable. Allow space for the equipment to move if the load shifts.
- Manoeuvre loaded or raised equipment carefully. Travel and turn slowly to avoid unit becoming unstable.

PERSONNEL

- All personnel must wear relevant personal protective equipment.
- Do not wear loose clothing or jewellery and tie back long hair to avoid becoming tangled or trapped in this equipment. You must make everyone in the work area aware of what you are doing.
- All personnel involved in the lifting operation must be competent to do so and must have been briefed in conjunction with this User Guide available from Conquip Engineering Group, the manufacturer.

EQUIPMENT MAINTENANCE & CLEANING

- It is mandatory that the equipment is thoroughly examined regularly, by a qualified engineer, to ensure compliance with relevant regulation/s. (Conquip recommend to carry out thorough examination every six months).
- This product may incorporate various loose and detachable items of lifting gear. Refer to the separate requirements for the safe use of those items.
- This equipment must be inspected by the responsible person before each use and then regularly, as determined by your risk assessment or working practice. If you have any concerns about condition or suitability do not use.

DO'S AND DON'TS

DO:

- ✓ Contact Conquip Engineering Group if you are unsure.
- ✓ Inspect all components prior to first use and each shift thereafter.
- ✓ Use suitable lifting equipment at all times.
- ✓ Ensure the surrounding ground profile and all possible surcharges have been included in the design information when selecting a box. Slopes near an excavation can increase the loads on the box.
- ✓ Maintain edge protection on all leading edges.
- ✓ Obtain a bespoke design where one is required for the specific ground conditions or use case. (Conquip can provide this service).
- ✓ Always maintain a safe batter of the unsupported parts of the trench in front of and behind the Drag Box.
- ✓ Ensure all pins and clips are fully engaged and secured.
- ✓ Be vigilant for catching fingers.
- ✓ Identify all buried services prior to excavation.
- ✓ Keep operatives clear of active slewing operations.

DON'T:

- ✗ Fly the boxes above excavation formation level unless permitted by a bespoke design.
- ✗ Have out-of-balance excavations at the sides. Fill with loose material.
- ✗ Enter the box during installation.
- ✗ Drag or lift the box from the rear struts.
- ✗ 'Snatch' the lifting chains when extracting the box from the ground.
- ✗ Enter a 'Confined Space' without suitable air monitoring equipment. Trench excavations may be considered as a 'Confined Space'

TERMS & CONDITIONS

CONQUIP ENGINEERING GROUP STANDARD PRODUCT WARRANTY

01. COMMENCEMENT

1.1 This Warranty shall commence on the Commencement Date and shall continue until the earlier of:

- (a) the Expiry Date; or
- (b) the date on which it may be voided in accordance with clause 4.1(b)

when it shall terminate automatically without notice.

02. DUTY OF GOOD FAITH

2.1 The Purchaser shall in the exercise of its rights under this Warranty and in the compliance with its obligations under this Warranty be subject to and shall in all respects owe and comply with a duty of good faith to the Warrantor.

03. NATURE AND EXTENT OF COVER

3.1 Subject to clause 3.2 the Warrantor agrees and undertakes to the Purchaser that it shall be liable to the Purchaser under and in accordance with the terms of this Warranty in the event that:

- (a) prior to the Expiry Date the Purchaser shall notify a Warranty Claim to the Warrantor; and
- (b) the Equipment or any relevant part of the Equipment shall have become unusable as the result of defective material or defective workmanship prior to the Expiry Date.

3.2 The Warrantor's obligation under clause 3.1 shall be expressly subject to the provisions of clauses 4, 5 and 6 and conditional upon the Purchaser's compliance in full with the provisions of clause 7.

04. RESTRICTIONS

4.1 The following restrictions apply to this Warranty:

(a) This Warranty is personal to the Purchaser and neither the legal benefit nor legal burden of this warranty may be assigned or novated or otherwise transferred by the Purchaser to any other party. Any purported assignment, novation or transfer shall not be binding upon the Warrantor.

(b) This Warranty shall be void in the event that the Purchaser:

(i) cannot provide authentic and original documentary evidence that the Purchaser has during the period between the Commencement Date and the Expiry Date complied with the Maintenance and Servicing Requirements; and/or

(ii) has, during the period between the Commencement Date and the Expiry Date, exceeded the Purchaser's Usage Cycle Parameters; and/or

(iii) has, during the period between the Commencement Date and the Expiry Date, exceeded the Purchaser's Use Parameters; and/or

(iv) has carried out, or procured the carrying out by any third party of, any repair to the Equipment or any part of the Equipment which is not an Authorised Repair; and/or

(v) has operated the Equipment after having replaced any part of the Equipment with a part which has not been supplied and fitted by the Warrantor; and/or

(vi) has modified the Equipment in any way prior to use.

05. EXCLUSIONS

5.1 The following are excluded from the scope of this Warranty:

(a) Loss of and/ or damage to the Equipment or any part of it resulting from any collision between the Equipment and any other fixed or stationary or mobile object whatsoever, irrespective of whether that collision was or was not caused by the Purchaser; and/or

(b) Loss of and/or damage to any personal property and/or possessions or other equipment not forming part of the Equipment but which is present in or about the Equipment; and/or

(c) loss and/or damage which is covered by any other insurance policy taken out and maintained by the Purchaser or in respect of which the Purchaser has a contractual obligation to do so; and/or

(d) loss and/or damage to the equipment which is consistent with the use by the Purchaser of the Equipment:

(i) in compliance with the Maintenance and Servicing Requirements; and

(ii) in compliance with the Usage Cycle Parameters; and

(iii) in compliance with the Use Parameters; and

(iv) having only carried out Authorised Repairs to the Equipment; and

(v) having all and any replacement parts fitted by the Warrantor; and

(vi) in unmodified form.

06. LIMITATION OF LIABILITY

6.1 The Warrantor's liability to the Purchaser shall be limited as follows:

- (a) The Warrantor shall not in any circumstances be liable to the Purchaser for indirect and/or consequential and/or economic loss suffered and/or incurred as the case may be by the Purchaser; and
- (b) The Warrantor shall only be liable to the Purchaser for the reasonable and proper costs reasonably and properly incurred by the Purchaser directly in connection with the repair and/or replacement (at the Warrantor's absolute discretion) of the Equipment or any part of the Equipment; and
- (c) The Warrantor's liability to the Purchaser shall notwithstanding any other provision of this Warranty, not in any circumstances exceed the Purchase Price of the Equipment.

07. WARRANTY CLAIMS

7.1 The Purchaser shall in respect of any claim against the Warrantor under this Warranty and within 24 hours of the occurrence of the subject matter of the Warranty Claim:

- (a) Complete in full and submit to the Warrantor a Warranty Claim in the form annexed to Schedule 4;
- (b) Provide date stamped or date identifiable photographs evidencing the claim; and
- (c) Make the Equipment or the relevant part of the Equipment available to the Warrantor for inspection within 48 hours of notification of the relevant Warranty Claim.

08. ENTIRE AGREEMENT

8.1 This Warranty constitutes the entire agreement between the parties and supersedes and extinguishes all previous promises, assurances, warranties, representations and understandings between them, whether written or oral, relating to its subject matter.

8.2 Each party agrees that it shall have no remedies in respect of any statement, representation, assurance or warranty (whether made innocently or negligently) that is not set out in this Warranty. Each party agrees that it shall have no claim for innocent or negligent misrepresentation or negligent misstatement based on any statement in this Warranty.

No variation of this Warranty shall be effective unless it is in writing and signed by the parties (or their authorised representatives).

09. WAIVER

No failure or delay by a party to exercise any right or remedy provided under this Warranty or by law shall constitute a waiver of that or any other right or remedy, nor shall it prevent or restrict the further exercise of that or any other right or remedy. No single or partial exercise of such right or remedy shall prevent or restrict the further exercise of that or any other right or remedy.

10. SEVERANCE

10.1 If any provision or part-provision of this Warranty is or becomes invalid, illegal or unenforceable, it shall be deemed deleted, but that shall not affect the validity and enforceability of the rest of this Warranty.

10.2 If any provision or part-provision of this Warranty is deemed deleted under clause 10.1 the parties shall negotiate in good faith to agree a replacement provision that, to the greatest extent possible, achieves the intended commercial result of the original provision.

11. THIRD PARTY RIGHTS

11.1 This Warranty does not give rise to any rights under the Contracts (Rights of Third Parties) Act 1999 to enforce any term of this Warranty.

12. GOVERNING LAW

12.1 This Warranty and any dispute or claim (including non-contractual disputes or claims) arising out of or in connection with it or its subject matter or formation shall be governed by and construed in accordance with the law of England and Wales.

13. JURISDICTION

13.1 Each party irrevocably agrees that the courts of England and Wales shall have exclusive jurisdiction to settle any dispute or claim (including non-contractual disputes or claims) arising out of or in connection with this Warranty or its subject matter or formation.

DESIGN CONFORMITY (EC & UK)

(01) This certificate meets the requirements of the Machinery Directive 2023/42/EC of the European Parliament and Council.

(02) This certificate meets the requirements of the Supply of Machinery (Safety) Regulations 2008.

DETAILS

NAME & ADDRESS OF MANUFACTURER:

Conquip Engineering Group Ltd, Unit 4, Waterbrook Estate, Alton, Hampshire. GU34 2UD

NAME & ADDRESS OF PERSON TO COMPILE TECHNICAL FILE:

Name: Daniel Critchley

Address: Conquip Engineering Group, Unit 4, Waterbrook Estate, Alton, Hampshire. GU34 2UD

NAME & ADDRESS OF AUTHORISED REPRESENTATIVE IF ONE HAS BEEN MANDATED BY THE MANUFACTURER:

N/A

NAME, ADDRESS, AND IDENTIFICATION NUMBER OF THE NOTIFIED BODY (01) OR APPROVED BODY (02), WHERE APPLICABLE:

N/A

EQUIPMENT DESCRIPTION

PRODUCT CODES	GENERAL DESCRIPTION / DESIGNATION	SAFE WORKING LOAD
TL100-00002	Standard Drag Box 5m Base	30 kPa
TL100-00003	Standard Drag Box 5m Extension	30 kPa
TL100-00010	Standard Drag Box 7m Base	20 kPa
TL100-00011	Standard Drag Box 7m Extension	20 kPa

HARMONISED STANDARDS & REGULATIONS

ITEM	CODE	DESCRIPTION
EC DIRECTIVE/ REGULATION:	2023/42/EC	Directive 2023/42/EC- new machinery directive
HARMONISED STANDARDS:	BS EN 13331-1:2002 BS EN 13331-2:2002	Trench Lining Systems
	BS EN 12811-2:2004	TW Equipment- Information on materials
	BS EN 1993-1-1 2005	Eurocode 3. Design of steel structures General rules and rules for buildings
	BS EN 1990:2002+A1:2005	Eurocode. Basis of structural design
OTHER REGULATIONS:	LOLER 1998	Lifting Operations and Lifting Equipment Regulations 1998 (LOLER)
	PUWER 1998	Provision and Use of Work Equipment Regulations 1998 (PUWER)

DECLARATION

PLACE OF DECLARATION:

Alton

DATE OF DECLARATION:

March 2026

I declare that the above equipment meets the Essential Health and Safety requirements of the

(01) Machinery Directive 2023/42/EC of the European Parliament and Council.

(02) Supply of Machinery (Safety) Regulations 2008 and Section 6 of the Health and Safety at Work Etc. Act 1974.

NAME:	POSITION:	SIGNATURE:
Daniel Critchley	Chief Executive Officer	

TALKING TO US IS EASY
WE'RE HERE TO HELP

Call us on 0333 300 3470
Email us at sales@cqegroup.com
www.cqegroup.com

