

User Guide

# CantiDeck Fixed Flush

---



## Product Information Specification

Item	Product Code
CantiDeck Fixed Flush 20	FF20
CantiDeck Fixed Flush 24	FF24
CantiDeck Fixed Flush 27	FF27
CantiDeck Fixed Flush 35	FF35
CantiDeck Fixed Flush 45	FF45

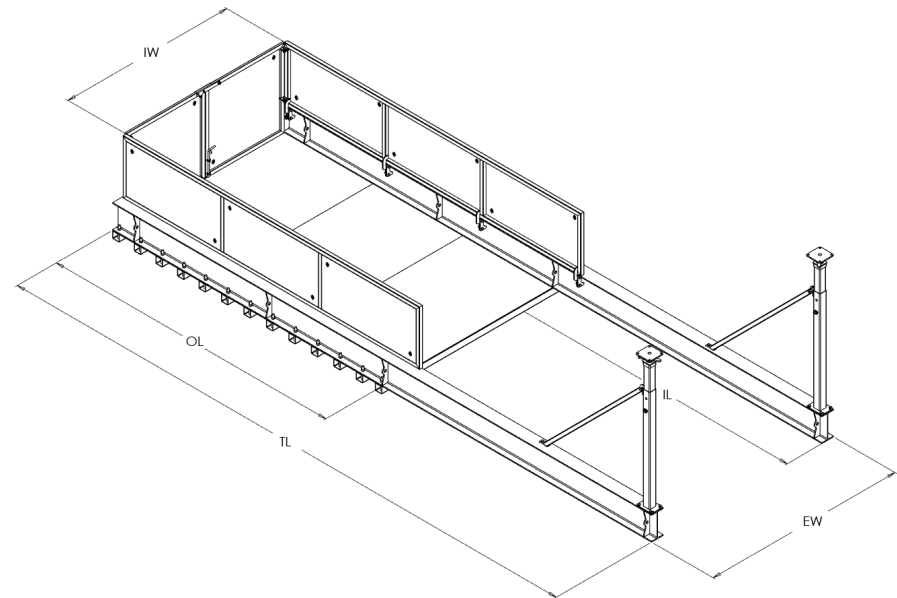

<sup>1</sup>Working Load Limit

Product Code	External Width	Internal Width	Outboard Length	Total Length	Weight	WLL <sup>1</sup>
FF20	2000mm	1550mm	4000mm	8000mm	1850kg	5000kg
FF24	2400mm	1950mm	4000mm	8000mm	2000kg	5000kg
FF27	2700mm	2250mm	4000mm	8000mm	2000kg	5000kg
FF35	3500mm	3050mm	4000mm	8000mm	2600kg	5000kg
FF45	4500mm	4000mm	4000mm	8000mm	2800kg	5000kg

## Product Information Overview

The Conquip CantiDeck is a crane loading platform used for moving equipment and materials efficiently in and out of structures during construction.

The Fixed Flush CantiDeck is ideal for situations where reduced head room places working height at a premium, and where maximum clearance is essential. The deck of the platform is suspended from the base of the main load-bearing beam, giving a true level, or 'flush' transition from the floor of the structure to the loading area.

### Key Benefits

- Fastest loading bay for relocation and installation.
- Large working load capacity and available with multiple configurations to suit most applications.
- Available in a variety of sizes, with bespoke solutions to suit requirements.
- Unique single prop design reduces the weight of the deck and the reaction loadings.
- Quick and simple to install and relocate.
- All installation and relocation training can be provided by our on-site training team.

## Original Working Instructions

# Usage Instructions

### Important Usage Notes

- Before starting the install, make sure that any exclusion zones are decided and that all personnel involved are aware. Also ensure that you have a plan in place to restrict access to those areas.
- When installing the platform, some of the team may be required to work at height. Ensure that you have the right equipment to provide access at height and ensure that all hand-held tools are tethered.
- The max permissible wind speed for lifting operations (including moving CantiDeck) is set by the crane manufacture/supplier. Project managers, appointed persons and lift supervisors must carry out a risk assessment of the planned lifts if the wind speed increases, even before it reaches the limit set by the crane manufacture/supplier taking into account the physical makeup of the item being lifted and where it is being lifted to.
- The doors on the end of the CantiDeck platforms could be a risk for possible unauthorised access or inadvertent opening. A control measure like a bolt or a padlock can be used to secure the doors shut. If you require this particular functionality, a risk assessment must be completed.
- In cases of high winds, please follow your health and safety executive guidelines.
- CantiDeck platforms must not be left unsupervised throughout the loading, unloading and whilst a load is on the deck.

### In advance

1. Communicate the date of install with all relevant site teams, according to standard site practice. Decide on exclusion zones and make all involved personnel aware.
2. Consider that some of the team may be required to work at height during the install. Make sure that you have suitable equipment in place to provide access at height and that all hand-held tools are tethered.
3. Check that any machinery or lifting equipment you are intending to use has the capability and a sufficient Working Load Limit to carry out the function that you require it to do.

### On the day

1. Before carrying out an installation, check that the site has the necessary safety precautions in place.

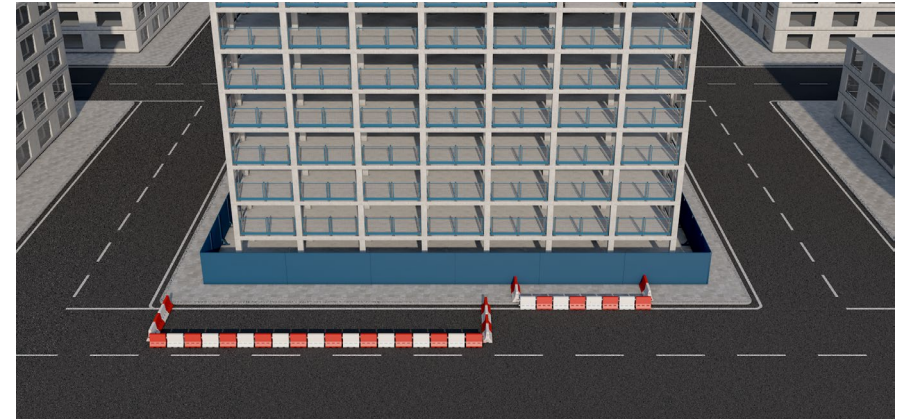

2. Create an exclusion zone at both delivery location and at the location that the platform is being installed.



3. Install location will need a suitable anchor point for leading edge safety equipment to attach.

4. Once the deck has been safely delivered to site, it will need to be removed from the vehicle.
5. The CantiDeck has 4 lifting points.
6. Attach 1 leg, of a 4 leg chain sling, to each lifting point.
7. Lift the deck from the transport, allow truck to exit and place flat on the floor.
8. Release the chains and begin assembling the CantiDeck starting with the side panels.

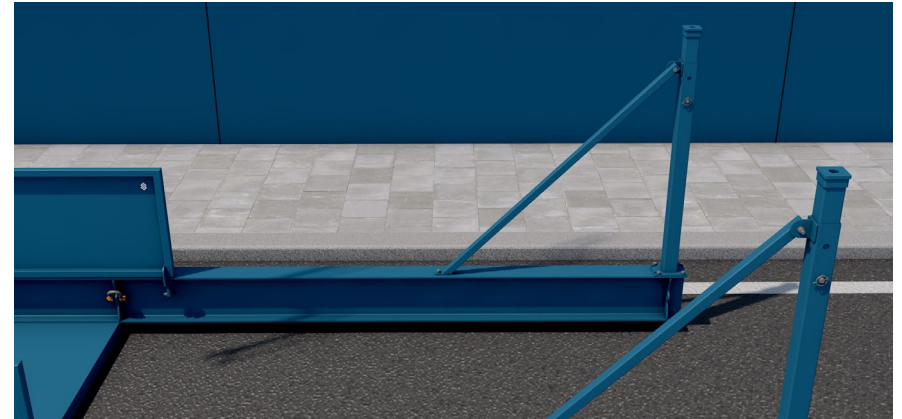
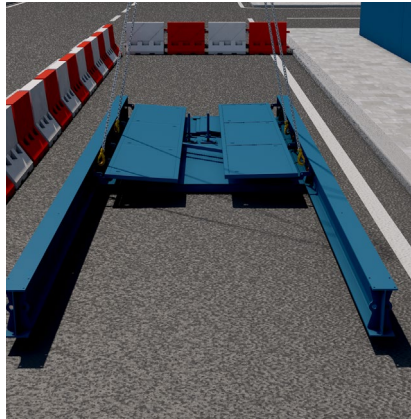

10. Prop and brace come pre-assembled ready for installation.
11. Lift the prop and brace into position and secure with bolts.

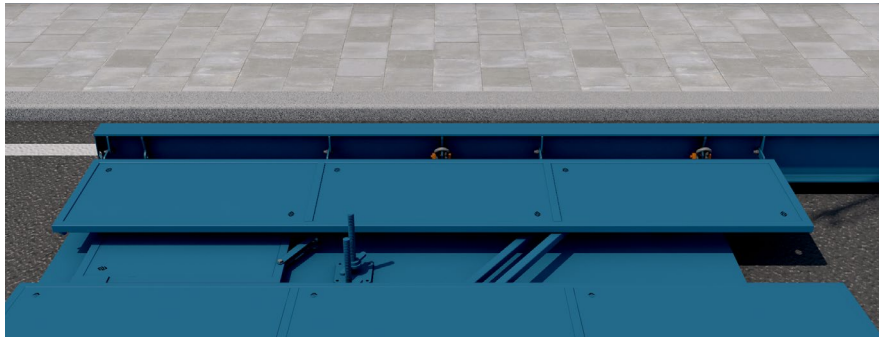

9. Rotate panel 90 degrees and fix the bolts.

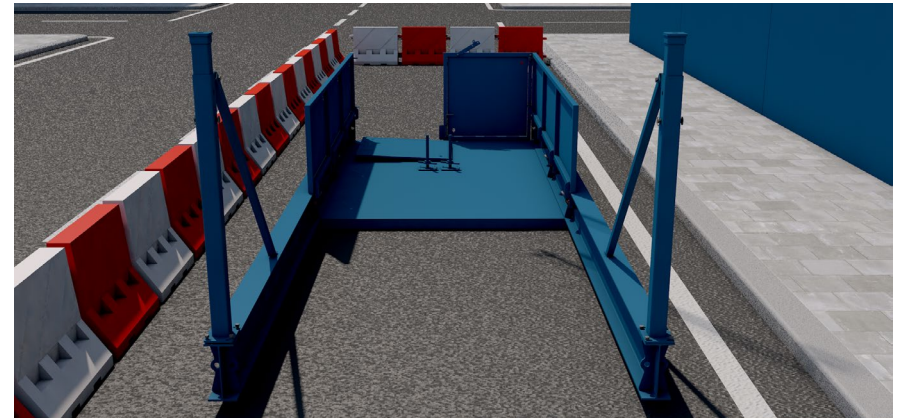

12. Lift one door and hang it on the hinges using M16 bolt & Nylon nut connections, ensuring it can pivot on its hinges.
13. Repeat with the other door and then secure the doors with the drop pin and latch.
14. Screw Jacks are to be carried up to the installation location separately.



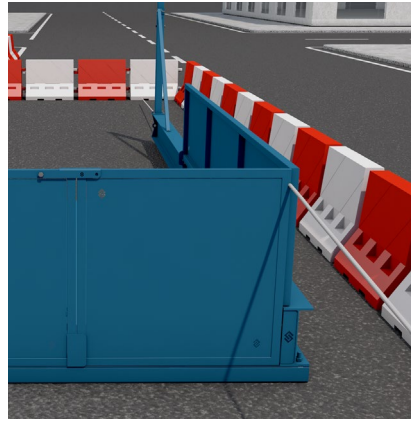
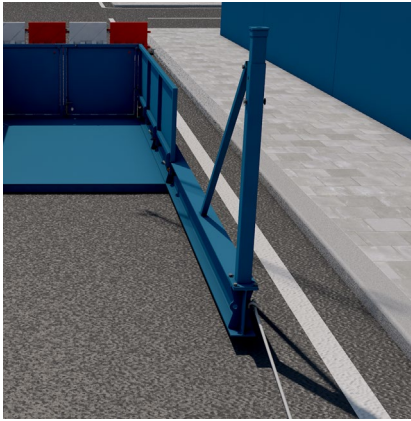

15. Prior to lifting, ensure tag lines are attached on the front and near the top of the deck on the rear, so they can be removed once installed.

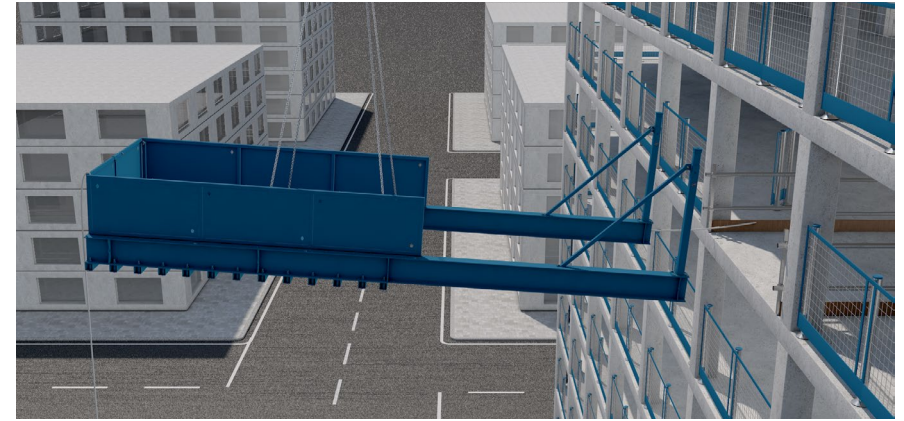

18. Ensure load path is clear and guide the deck into position on the edge of the building.

19. Use the tag lines to guide the platform into the building.

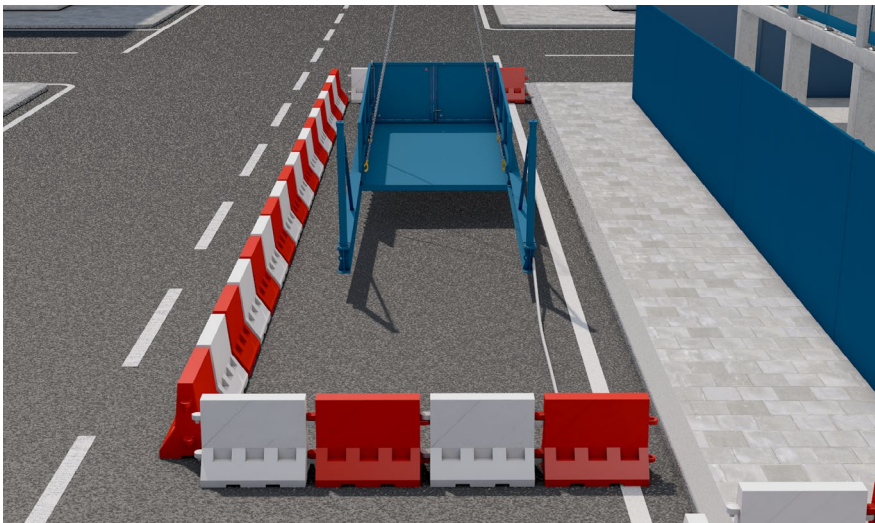

16. Attach the 4 leg chain to the lifting points. The use of the chain shorteners may be required to adjust the level of the deck.

17. Take the weight with the crane and lift until the platform sits clear of the ground. The deck should be tilted back slightly.

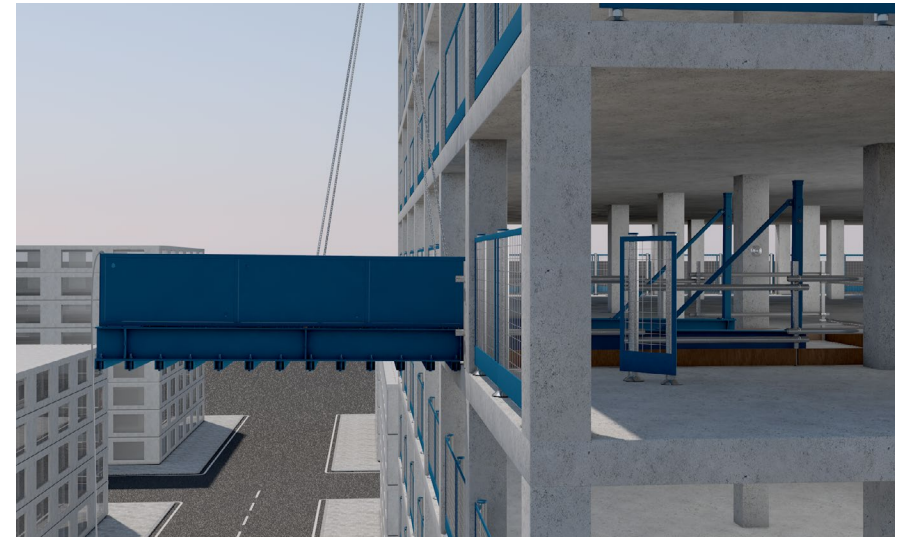

20. Once the platform is butted up against the slab edge, lower off the crane until the beams are sat flush on the slab.

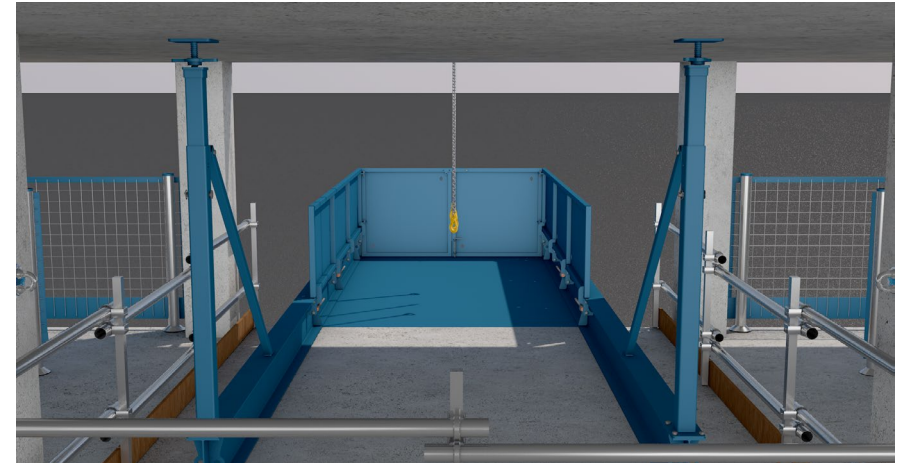
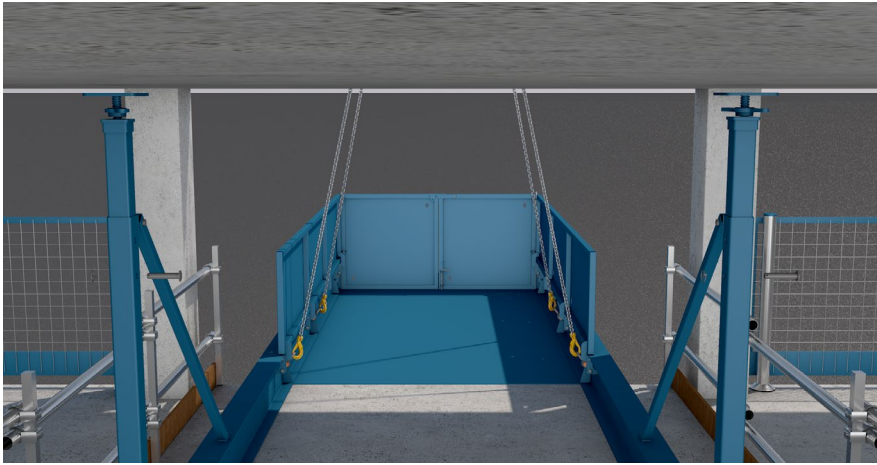

21. Screw Jacks should now be added to the Props.
22. Remove pins from the prop legs and slide the legs up until they are within 150mm of the ceiling. Re-insert the pin ensuring the safety pin is also in position.

24. Check the screw jacks are tightly secured, slowly lower the crane down and disconnect the lifting chain.

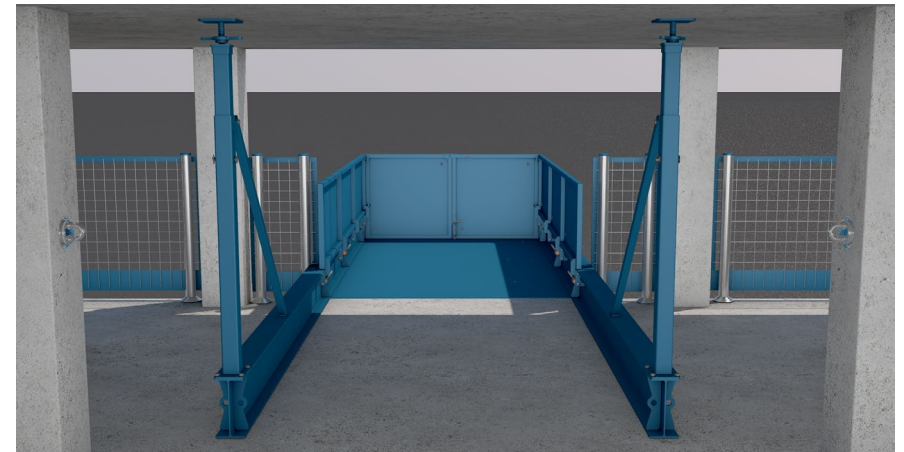
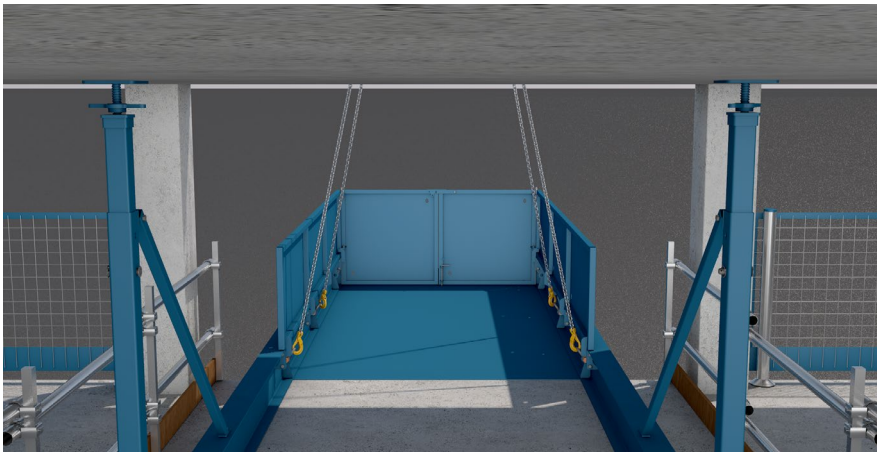

23. Ensure that the base beams are flat on the ground and they vertical legs are at 90 degrees to the base beam. Tighten the screw jacks until they are hand tight, then hammer just 1/4 turn extra.

25. Remove the exclusion zone on the slab, ensuring that any gaps at the side of the deck are completed with edge protection.
26. The Cantideck has been successfully installed.



## Original Working Instructions Usage Instructions

### Removal Instructions

1. Remove the edge protection from the side of the deck to allow safe removal of the deck.



2. Prior to lifting, attach a tag line to the front and rear of the deck in opposite corners.

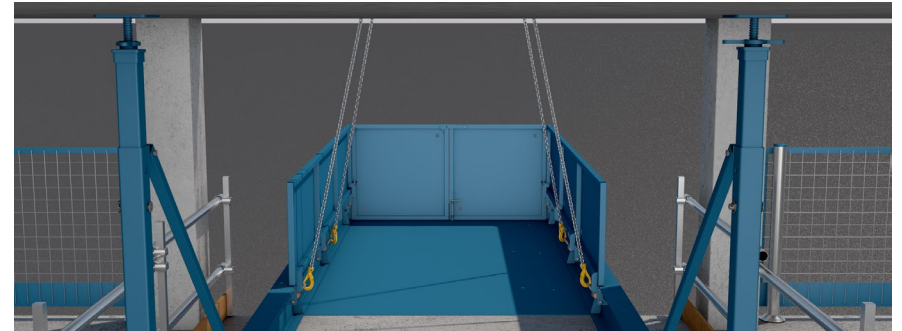
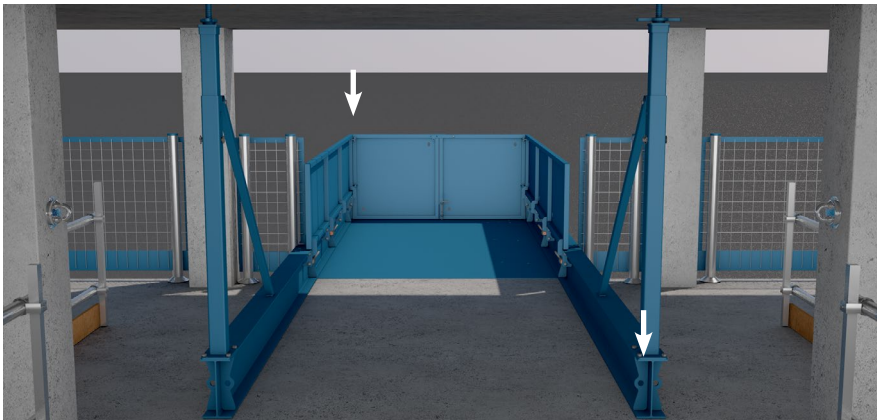

3. Attach 1 leg of the 4-leg chain to each lifting point.
4. Slowly take the weight of the deck, take care not to lift the deck until the props are released.

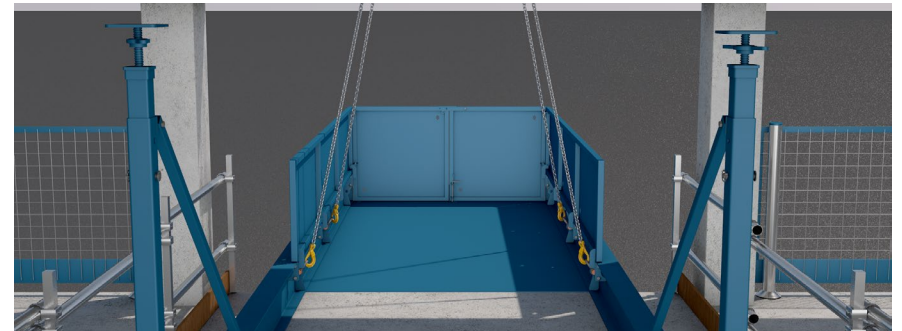

5. Loosen the prop heads from the soffit.
6. Remove the prop pin and lower the props as far as possible.

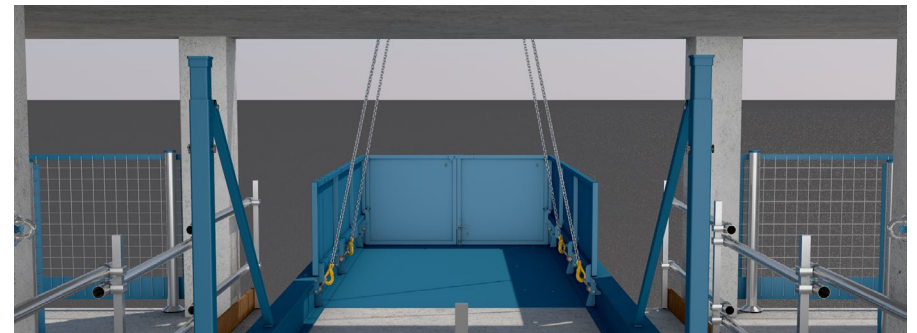

7. Re-insert the prop pins and clips, then remove the prop heads.

8. Slowly lift the deck and manoeuvre it out of the building.

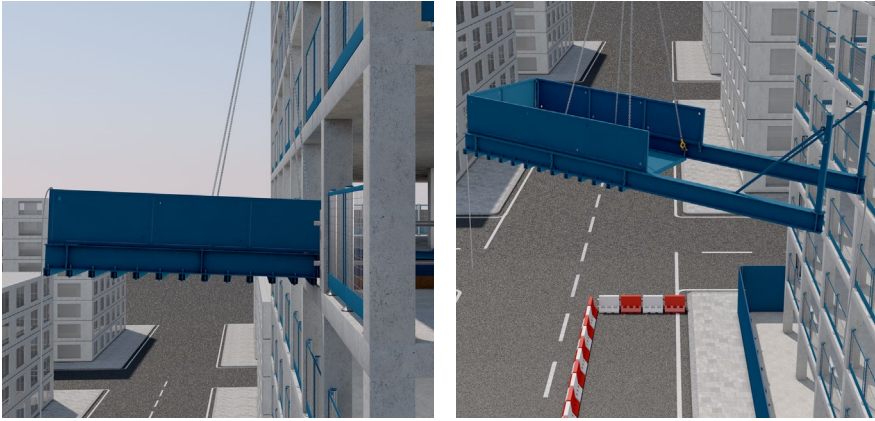

9. The deck can now be lowered to the ground to be made ready for transport or installed in a new location.

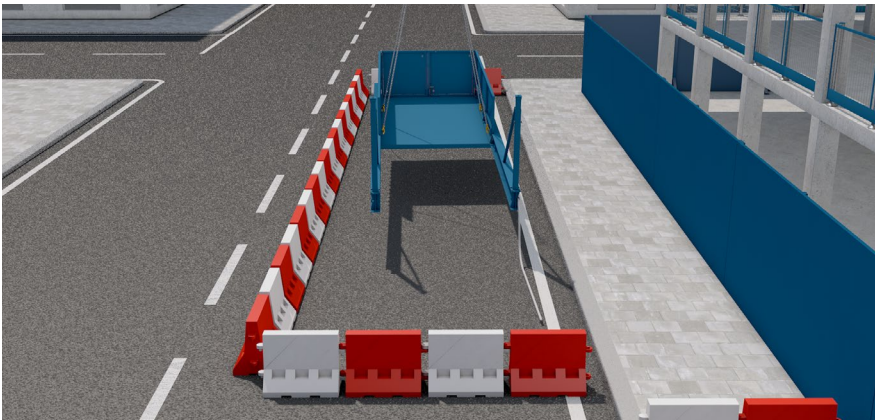



## CantiDeck Fixed Flush Inspection Checklist

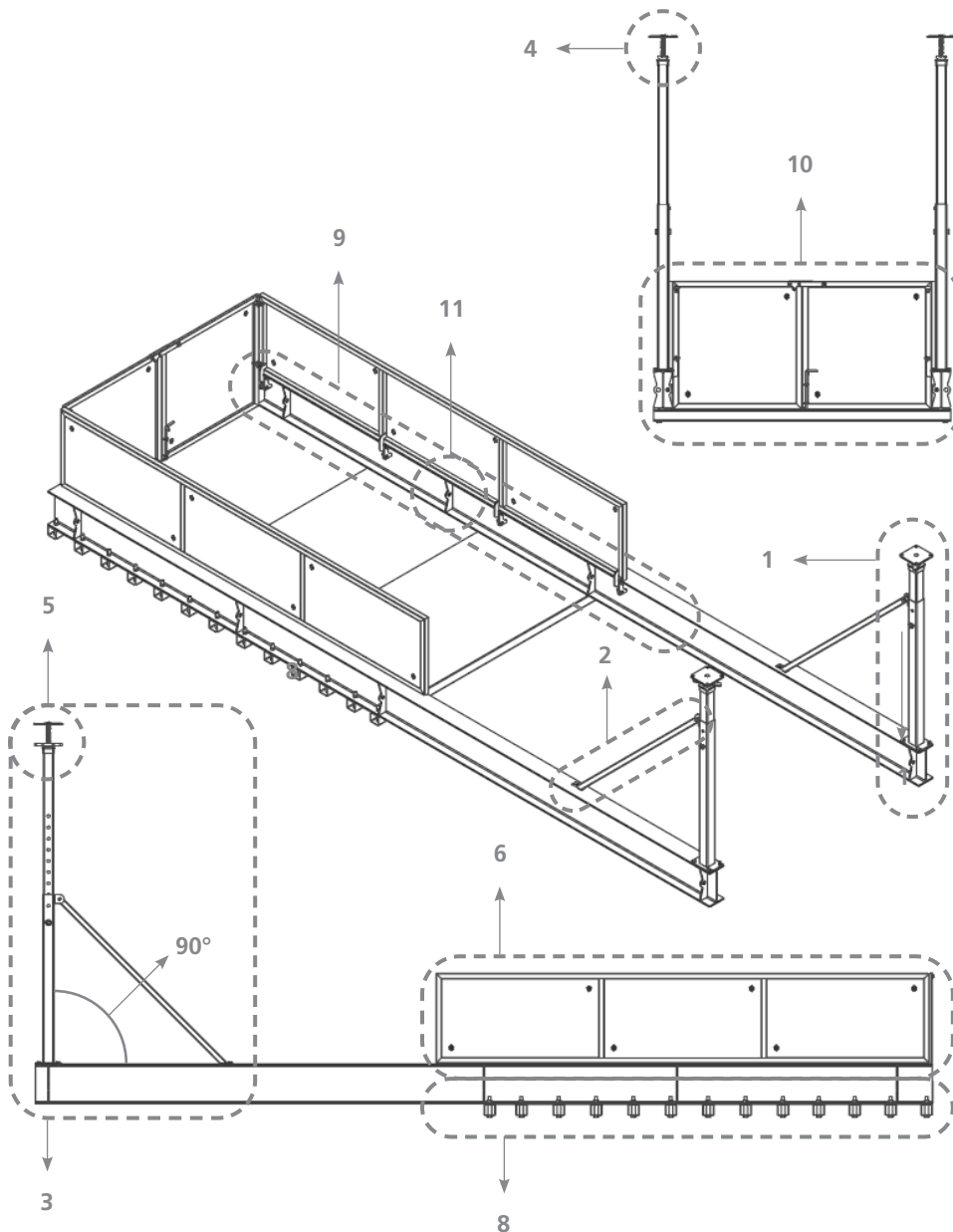

## CantiDeck Fixed Flush Inspection Checklist

Installation engineer to carry out full visual check on the following items to ensure that they are correctly fitted in place & no damage or defects have occurred.

**CONTRACTOR:**

**SITE LOCATION:**

**INSTALLED AT:**

**PLATFORM TYPE:**

ITEM TO CHECK	CHECKED
01 / Check base prop and leg assembly	
02 / Check brace bar assembly	
03 / Check prop legs are plumb	
04 / Check prop head to spreader beam fixings or Prop flat heads to slab (if applicable)	
05 / Check screw jacks are tight and to the correct height (max 150mm of thread)	
06 / Check handrail assembly	
07 / Check weld for platform deck, beams and propping system	
08 / Check all deck plate to inner beam bolts in place and complete (if applicable)	
09 / Check sides, condition / complete (including fixing bolts / pins)	
10 / Check doors, condition / complete (including safety pin) / locking assembly	
11 / Check lifting eyes & shackles x 4	
12 / Check all nuts & bolts are in place and tight	
13 / Check edge protection installed up to platform edge	
<b>Other Notes</b> (Record of movements / damages / faults ect)	

The above CantiDeck has been inspected according to the manufacturers recommendations:

**DATE OF INSPECTION:**

**INSPECTED BY (SIGN):**

(PRINT):

## Original Working Instructions Usage Instructions

### Controlling the Load

- It is advised that slingers should attach a tag line to the load control movement of the load during the lift.

### Landing the Load

- Ensure the landing area is prepared and ready to receive the load before lifting and transporting the load.

### Chain Sling Storage

- Never lower the load onto the chain. When lifting operations are complete and the 4 Leg Chain Sling is free of any load, ensure the chain is clean, ready for the next use, and store on a Conquip Chain Storage Rack to prevent damage.

#### Grade 8

Chain Size	Three and Four Leg	
	0-45°	45-60°
7mm	3.1	2.2
8mm	4.2	3.0
10mm	6.7	4.75
13mm	11.2	8.0
16mm	17.0	11.8
20mm	26.5	19.0
22mm	31.5	22.4
26mm	45.0	31.5
32mm	67.0	47.5

#### Grade 10

Chain Size	Three and Four Leg	
	0-45°	45-60°
6mm	2.9	2.1
8mm	5.3	3.8
10mm	8.4	6.0
13mm	14.0	10.0
16mm	21.0	15.0
20mm	33.6	24.0
22mm	40.0	28.0
26mm	55.7	39.8
32mm	85.0	60.0

Please refer to The Conquip 4 Leg Chain Sling User Guide for more information.

## Original Working Instructions Safety Instructions

### Basic Safety

A site-specific Risk Assessment, and lift plan where applicable, must be completed by the responsible person before using this equipment to control risks, produce a safe system of work and ensure safety for you, your colleagues and others. Your risk assessment will determine the correct Personal Protective Equipment (PPE) for the task you are doing. You must use it. Conquip recommends that you should wear:

- Suitable clothing
- Gloves
- Hard hat
- Protective footwear (steel toecaps)
- Safety glasses



### Important Safety Notes

- Read these instructions before using this equipment. If there is anything you do not understand or if you have any concerns do not use this equipment. Contact your supervisor or Conquip Engineering Group for advice.
- You must check that you have considered all the safety requirements for the task you are doing and that this equipment is suitable.
- You must protect bystanders and the general public by preventing access to the working area.
- Do not use this equipment if you are tired, unwell or under the influence of alcohol or drugs. If you are taking any medicine or undergoing treatment you should inform your supervisor.
- The doors on the end of the CantiDeck platforms could be a risk for possible unauthorised access or inadvertent opening. A control measure like a bolt or a padlock can be used to secure the doors shut. If you require this particular functionality, a risk assessment must be completed.

## Usage & Transportation

- Never unevenly load this equipment.
- The weight of the equipment, together with its attachments, must be added to the weight of the load when calculating the total load that will be imposed on the lifting apparatus / operating machine.
- This equipment must be used in conjunction with the load ratings of the lifting apparatus / operating machine. (Refer to the manufacturers' load ratings and original working instructions).
- Make sure you know how to use this equipment and understand all aspects of its operation in case of emergency.
- This equipment weighs more than 25kg. Do not lift or manhandle without machine assistance.
- Do not operate this equipment near overhead power lines.
- Take care in confined spaces, near ceilings or similar hazards. This equipment was designed for vertical lifting. Do not drag, or swing.
- Before operating this equipment, check that you have enough space for you to work safely and make sure that the working area is clear of hazards, obstructions and personnel.
- Before lowering equipment make sure that the landing zone is clear and capable of accepting the size and weight of the load.
- Crush Risk. Keep hands and feet clear of the equipment at all times to avoid injury.
- Do not exceed the maximum Working Load Limit (WLL) shown on the serial plate. Ensure that the WLL on the individual lift points is not exceeded.
- Before lifting, check that the load is secured, balanced and stable. Allow space for the equipment to move if the load shifts.
- Do not leave unattended. The operator must remain in control of this equipment whenever it is loaded.

## Personnel

- All personnel must wear relevant personal protective equipment.
- Do not wear loose clothing or jewellery and tie back long hair to avoid becoming tangled or trapped in this equipment. You must make everyone in the work area aware of what you are doing.
- All personnel involved in the lifting operation must be competent to do so and must have been briefed in conjunction with this User Guide available from Conquip Engineering Group, the manufacturer.

## Equipment Maintenance & Cleaning

- It is mandatory that the equipment is thoroughly examined regularly, by a qualified engineer, to ensure compliance with relevant regulation/s. (Conquip recommend to carry out thorough examination every six months).
- This product may incorporate various loose and detachable items of lifting gear. Refer to the separate requirements for the safe use of those items.
- When not being used, store the unit in a clean, upright condition and in a safe place where it will be protected from thieves and unauthorised users.
- This equipment must be inspected by the responsible person before each use and then regularly, as determined by your risk assessment or working practice. If you have any concerns about condition or suitability do not use.

## Disclaimer

---

### Warranty

The products supplied by Conquip Engineering Group are all guaranteed by a 12 month warranty.

Apart from where exceptions apply, Conquip Engineering Group promises to repair or replace any fault which the Company considers to be due to defective material or workmanship within 12 months of the date of sale, at no additional cost.

- Faults arising from unauthorised alterations (see modifications section below for full details).
- Damage caused by abuse, neglect, misuse or falling.
- Damage caused because of failure to follow transportation, storage, loading, cleaning or operating instructions.
- Replacement or repair of components due to fair wear and tear.
- Any consequential damage or wear arising from the use or fitting of additional or non-standard parts.

### Modifications

If any third-party modifications or alterations, involving drilling, welding, cutting or distortion of materials in any form, are to be carried out on the product, Conquip Engineering Group must provide full written approval prior to the work being carried out.

Alterations, modifications, additions or repairs must be carried out by Conquip Engineering Group's recognised distributors, if they are not carrying out the work themselves.

Conquip Engineering Group operate a continuous improvement policy and therefore reserve the right to alter technical specifications and user guide details at any point without notice.

Conquip Engineering Group will not cover or reimburse any transportation and/or shipment costs to and from their premises or their recognised agents, or any material and/or labour costs for repair, replacement or assessment against a warranty claim.

Conquip Engineering Group and/or their directors, employees, insurers or recognised agents will not be held liable for consequential damages, losses or expenses relating to the inability to use the product correctly for its purpose.



# EC Declaration of Conformity

## In accordance with EN ISO 17050-1:2004

Declaration: As defined by the Machinery Directive 2006/42/EC and subsequent amendments

We, CONQUIP ENGINEERING GROUP, herewith declare that the following indicated equipment meets the fundamental health and safety requirements concerning the EU guide line(s), due to their design and manufacture.

This declaration will be rendered null and void if the machine is changed without our approval.

**Signed:**



**Dated: 2024**

**Garry Critchley, Chief Executive Officer**

<b>Product Code(s):</b>	FF20 / FF24 / FF27 / FF35 / FF45
<b>EC Directive/ Regulation:</b>	2006/42/EC, Lifting Operations and Lifting Equipment Regulations 1998 Provision and Use of Work Equipment Regulations 1998
<b>Harmonised Standards:</b>	BS EN ISO 12100:2010 BS EN 13155
<b>General Description/ Designation:</b>	CantiDeck Fixed Flush 20 – FF20 CantiDeck Fixed Flush 24 – FF24 CantiDeck Fixed Flush 27 – FF27 CantiDeck Fixed Flush 35 – FF35 CantiDeck Fixed Flush 45 – FF45
<b>WLL:</b>	FF20, FF24, FF27, FF35, FF45 = 5000kg

## Important Notes

- This User Guide is for this Conquip product only.
- Any movements of the product must be thoroughly planned before the work commences to identify potential hazards and assess risk.
- All personnel involved in lifting and transportation of this product must have read this User Guide and must be properly briefed.
- You must be competent, alert and medically fit when using this equipment. If you have a medical condition, a mental or physical disability, you must seek advice from a medical professional before using this equipment.

Talking to us is easy

**We're here to help**

Call us on +44 (0) 333 300 3470

Email us at [sales@cqegroup.com](mailto:sales@cqegroup.com)

[www.cqegroup.com](http://www.cqegroup.com)

**Conquip Engineering Group**

Waterbrook Estate, Alton, Hampshire, GU34 2UD