

USER GUIDE

LIGHTWEIGHT TRENCH BOX

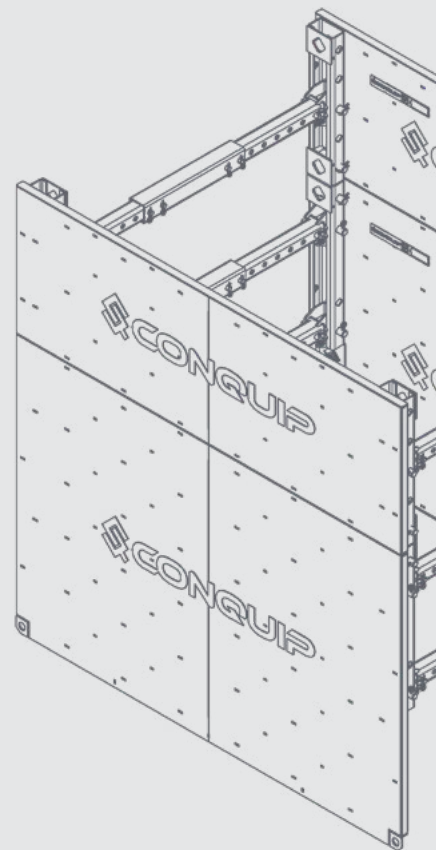
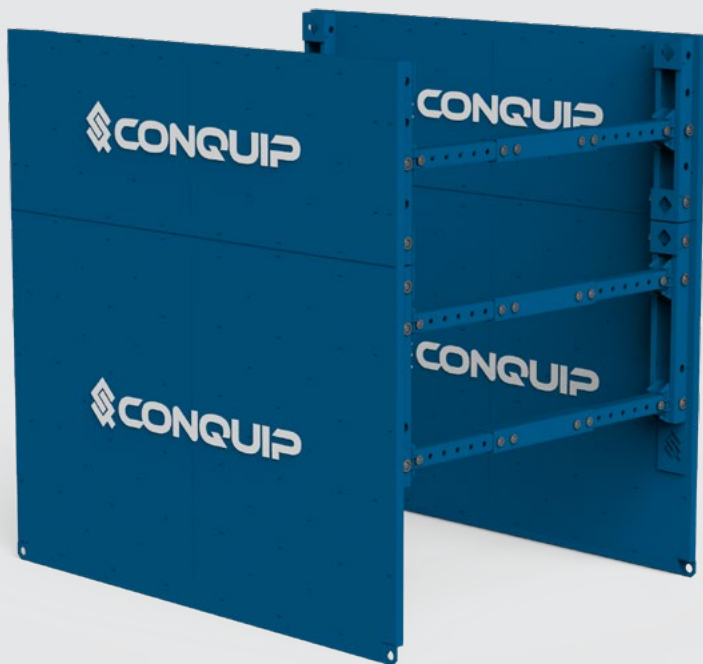

DISCLAIMER

Conquip Engineering Group has prepared this document to provide guidance on the safe erection, use and dismantling of the product it relates to. Conquip Engineering Group is committed to ensuring our customers are informed and supported throughout the use of our equipment. This document does not relieve users of their own duty of care.

This user guide is based on the user being familiar with this type of equipment, exercising all reasonable skill and care in its use. All work with the equipment should only be undertaken with suitably competent and supervised operatives.

The user should take into account this user-guide, as well as all other available documentation and guidance provided by Conquip and the wider construction industry. The user must remain compliant with relevant safety laws and industry good practice. Considerations for a Safe System of Work should include, but are not limited to:

- Safe handling and lifting of equipment
- Provision of safe access and prevention of falls from height
- Identification of buried services and unexploded ordinance
- Working within confined spaces
- Inspection and suitability of ground conditions for the equipment selected

Your attention is drawn to the Construction Design Management Regulations 2015 whereby the person selecting a product for use is a designer and must take account of the health and safety issues arising from its use.

Conquip Engineering Group does not accept any responsibility for the user's operation of the equipment.

Conquip Engineering Group operates a continuous improvement policy and therefore may change the contents of this document at any time without notice.

Your statutory rights are unaffected

If in doubt, ASK Conquip Engineering Group for assistance.

CONTENTS

PRODUCT INFORMATION

INTRODUCTION	04
SPECIFICATION	05
WORKING WIDTHS & STRUT TYPES	06
YOUR INVENTORY	08
COMPONENT WEIGHTS	10
TECHNICAL PERFORMANCE	12
GENERAL GUIDANCE	14

USAGE

ASSEMBLY INSTRUCTIONS	16
INSTALLATION INSTRUCTIONS	18
EXTRACTION INSTRUCTIONS	22

SAFETY

SAFETY INSTRUCTIONS	26
USAGE AND TRANSPORT	27
PERSONNEL	28
EQUIPMENT MAINTENANCE & CLEANING	28
DO'S & DONT'S	29

LEGAL

TERMS AND CONDITIONS	30
EC DECLARATION OF CONFORMITY	34
STANDARDS AND REGULATIONS APPLICABLE	35

INTRODUCTION

OVERVIEW

The Conquip Lightweight Trench Box is a simple to assemble, two-sided trench lining support system designed to be installed by an excavator using the 'dig and push' technique, or by carrying out the excavation on self supporting ground, then lowering each box into place.

The Lightweight Trench Box is normally used where ground movement is not critical. Lightweight Trench Boxes are generally not appropriate for unmanaged or waterlogged ground conditions. The size of the system required depends on maximum trench depth and working width requirements. Extensions are available for trench depths of up to 4 metres and working widths of up to 4 metres.

Manufactured in the UK from quality British and EU steel.

Conquip also supplies a full range of suitable lifting and extraction chains, edge protection and trench access accessories.

SPECIFICATION

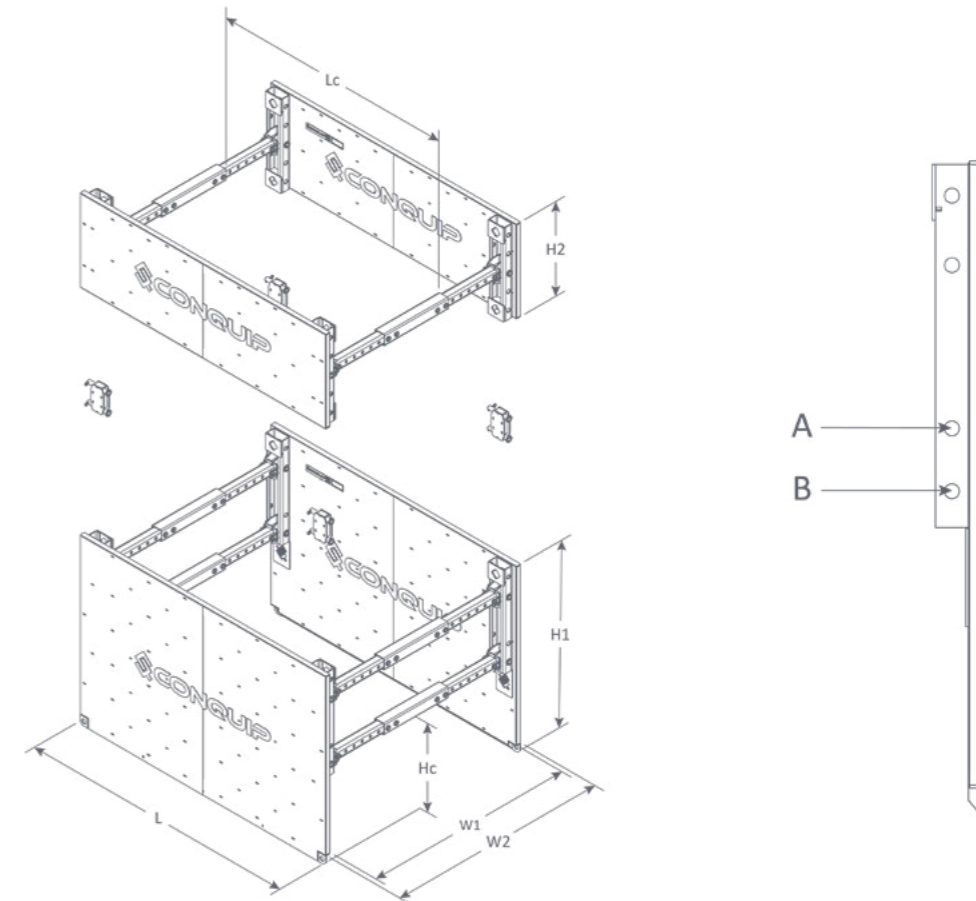

	IDENTIFIER	MIN	MAX
BASE	ASSEMBLED WEIGHT (kg)	1097	1531
	HEIGHT (mm)	H1	2000
EXTENSION	ASSEMBLED WEIGHT (kg)	643	860
	HEIGHT (mm)	H2	1000
	LENGTH (mm)	L	3000
	MAX TRENCH DEPTH* (mm)		4000
	INTERNAL WIDTH (mm)	W1	3985
	EXTERNAL WIDTH (mm)	W2	4095
	CLEARANCE BELOW STRUT (mm)	Hc	1030 (Position A)
			940 (Position B)
	CLEARANCE BETWEEN STRUTS (mm)	Lc	2600

*Based on a base box with 2No extension boxes, greater depths may be achievable with a bespoke design.

LIGHTWEIGHT TRENCH BOX

WORKING WIDTHS AND BOX WEIGHTS



*Weights include two panels, two levels of struts and associate components
 **Weights include two panels, one level of struts and associate components

STRUT TYPE	BOX INTERNAL WORKING WIDTH (mm)		BOX EXTERNAL WIDTH (mm)		TOTAL WEIGHT OF BASE* (kg)	TOTAL WEIGHT OF EXTENSION** (kg)
	MIN	MAX	MIN	MAX		
1	550		660		1097	643
2	650		760		1108	649
3	750		860		1119	654
4	850		960		1185	688
5	950		1060		1196	693
6	1050		1160		1151	671
7	1150		1260		1218	704
8	1250	1650	1360	1760	1273	732
9	1850	2250	1960	2360	1339	765
10	2260	3260	2370	3370	1451	820
11	2985	3985	3095	4095	1531	860

STRUT TYPES

STRUT SELECTION AND ASSEMBLY WEIGHTS

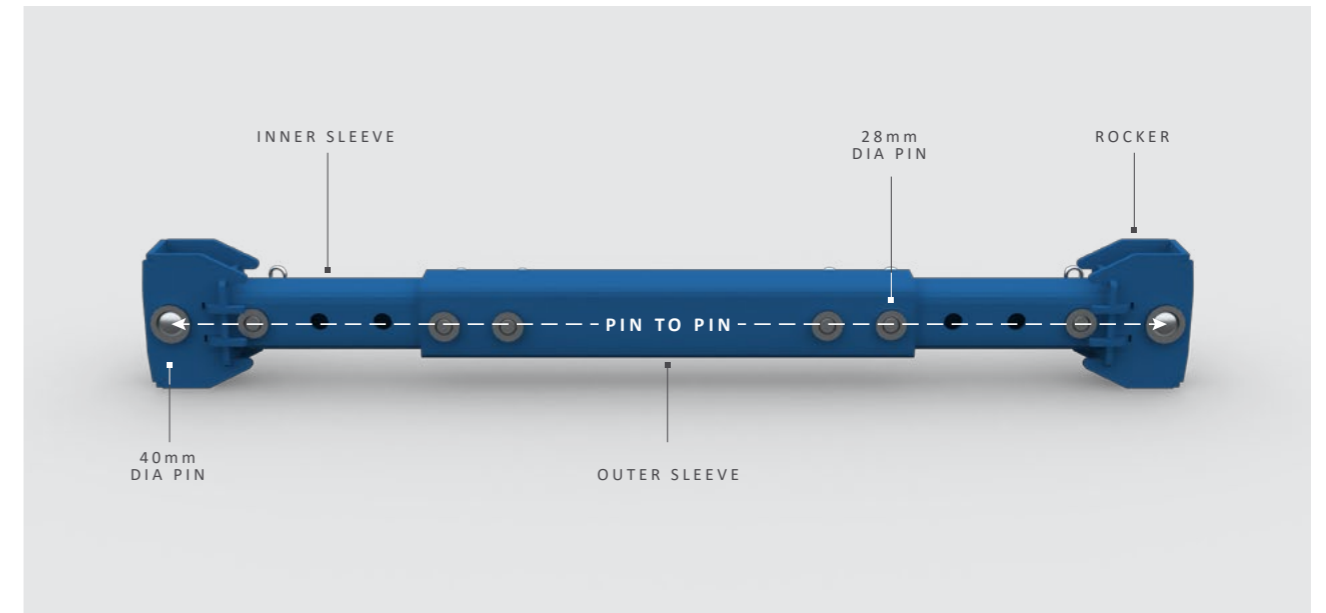

STRUT TYPE	KIT CODE	INNER SLEEVE								OUTER SLEEVE				STRUT PIN TO PIN LENGTH (mm)		STRUT ASSEMBLY WEIGHT (kg)				
		PRODUCT CODE								LENGTH (mm)										
		TL900081	TL900074	TL900080	TL900047	TL900116	TL900042	TL900289	TL900291	280	380	480	780	380	780	1790	2515	MIN	MAX	
1	TL200-00011	1																516	31.7	
2	TL200-00012		1															616	34.4	
3	TL200-00013			1														716	37.2	
4	TL200-00014	2					1											816	53.8	
5	TL200-00015	1	1				1											916	56.6	
6	TL200-00016				1													1016	45.4	
7	TL200-00017		1	1			1											1116	62.1	
8	TL200-00018			2						1								1216	1616	75.8
9	TL200-00019				2					1								1816	2216	92.3
10	TL200-00020				2							1						2226	3226	120.1
11	TL200-00021				2								1					2951	3951	140.2

YOUR INVENTORY

BASE BOX

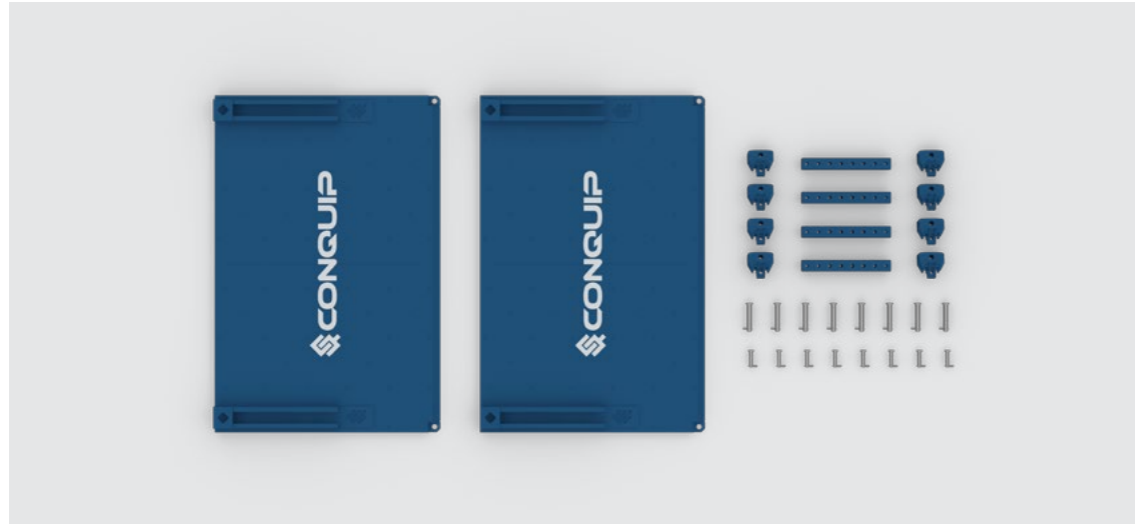

EXAMPLE INVENTORY OF STRUT TYPE 6, KIT CODE TL200-00016

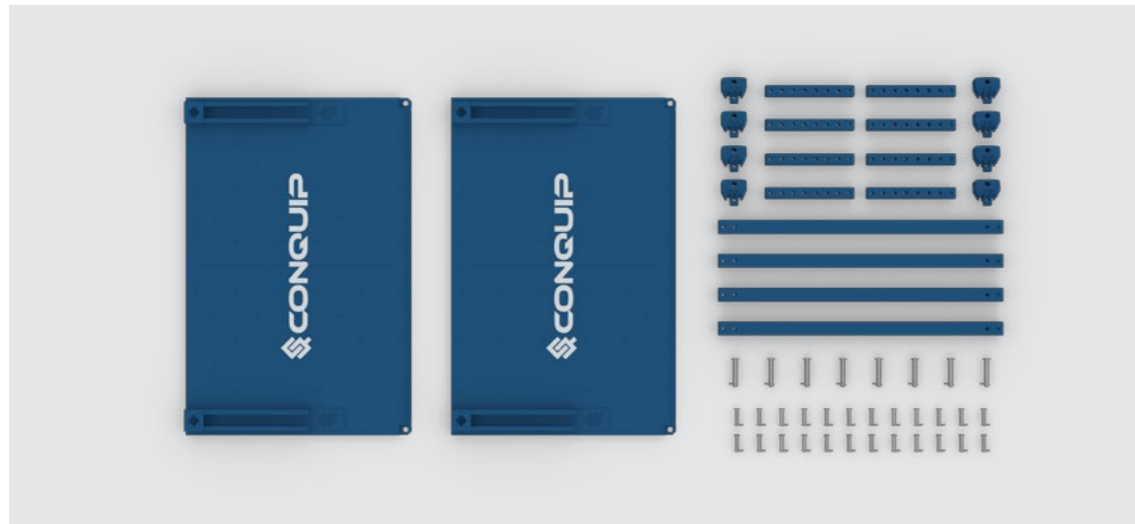

EXAMPLE INVENTORY OF STRUT TYPE 11, KIT CODE TL200-00021

ITEM	Box Panels	Rockers	Strut Kits	40mm Pins	28mm Pins	R-Clips
QUANTITY	2	8	4	8 (2 PER STRUT KIT)	8 / 24 (DEPENDENT ON WORKING WIDTH)	1 (PER PIN)

YOUR INVENTORY

EXTENSION BOX

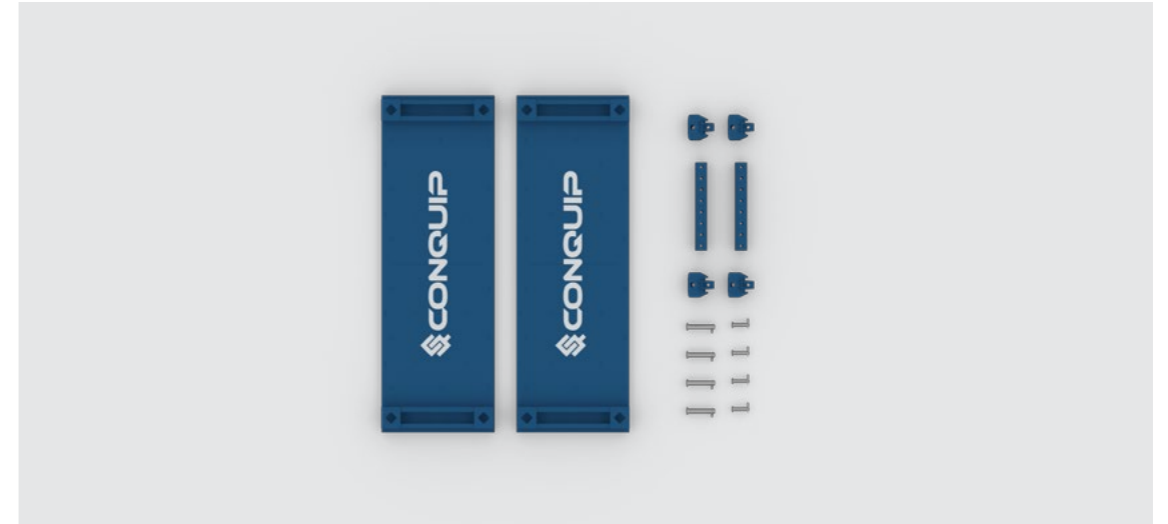

EXAMPLE INVENTORY OF STRUT TYPE 6, KIT CODE TL200-00016

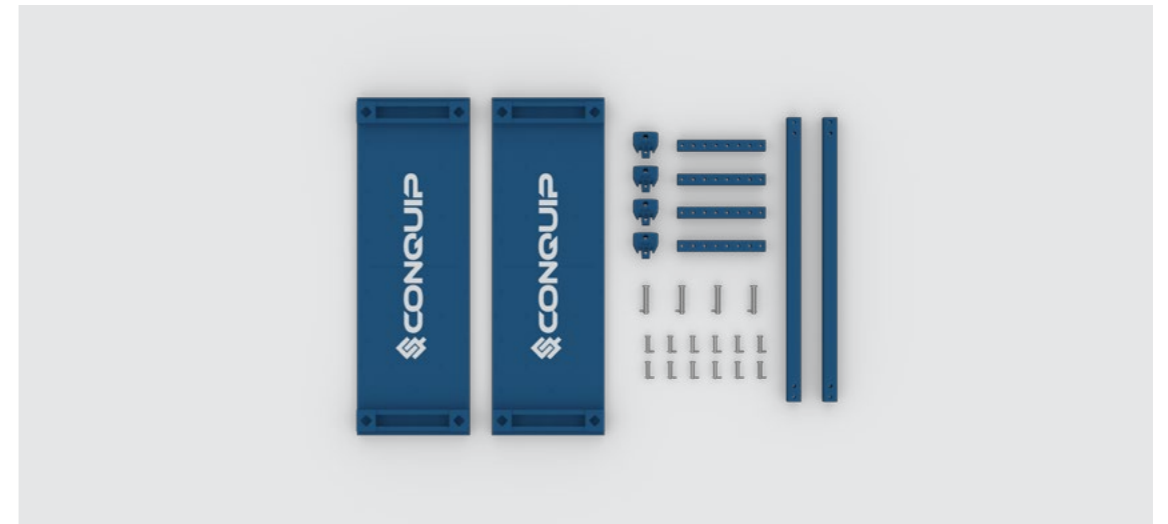

EXAMPLE INVENTORY OF STRUT TYPE 11, KIT CODE TL200-00021

ITEM	Box Panels	Rockers	Strut Kits	40mm Pins	28mm Pins	R-Clips
QUANTITY	2	4	2	4 (2 PER STRUT KIT)	4 / 12 (DEPENDENT ON WORKING WIDTH)	1 (PER PIN)

COMPONENT WEIGHTS

BOXES



3.5m Base Panel



3.5m Extension Panel

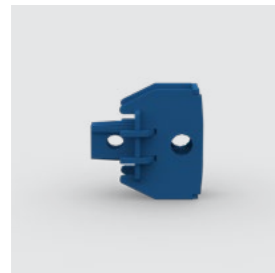

Rocker



28mm Dia Pin with R-clip



40mm Dia Pin with R-clip

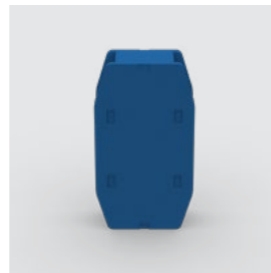

Box Connector

ITEM CODE	ITEM	WEIGHT (kg)
TL900141	3000mm Base Panel	485
TL900142	3000mm Extension Panel	290
TL900041	Rocker	10
TL900044	28mm Dia Pin with R-clip	1
TL900043	40mm Dia Pin with R-clip	2.5
TL900046	Box Connector	10

COMPONENT WEIGHTS

STRUTS

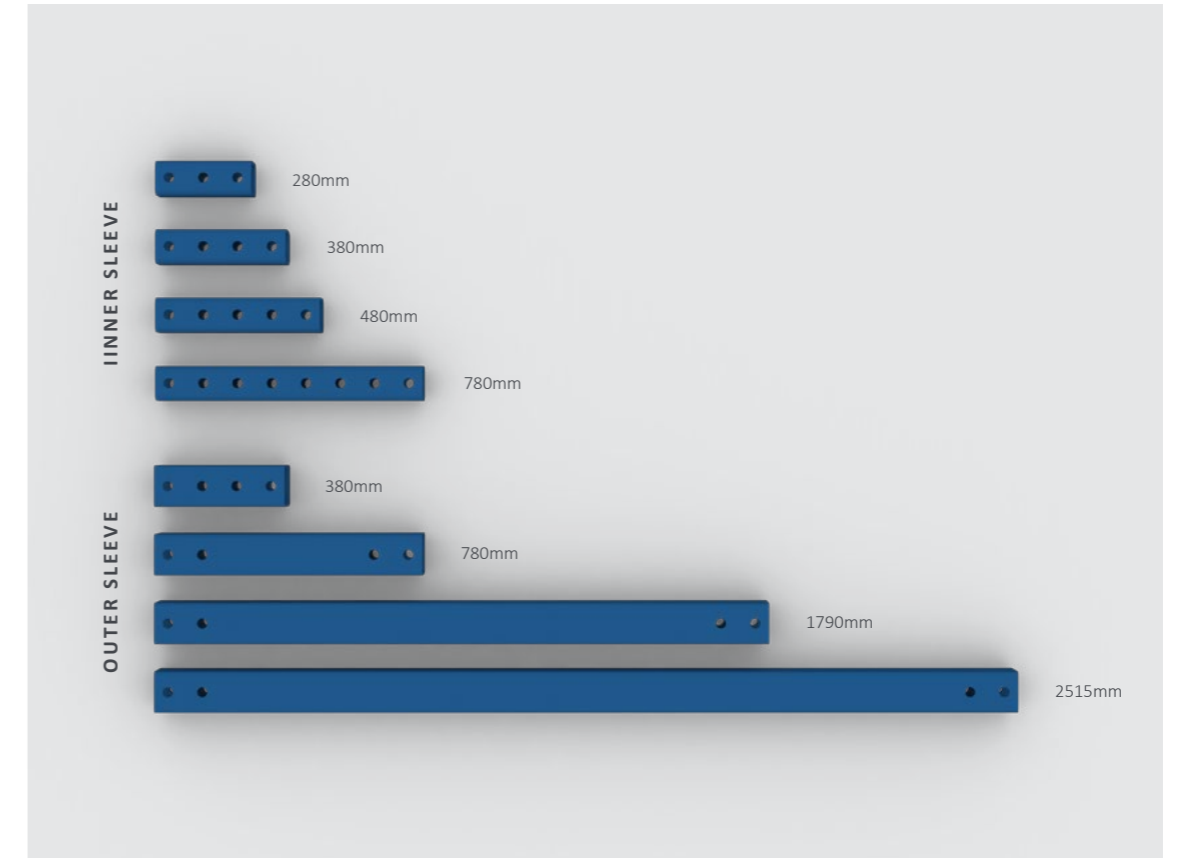

ITEM CODE	ITEM	WEIGHT (kg)
TL900081	Inner sleeve (280mm)	7.7
TL900074	Inner sleeve (380mm)	10.4
TL900080	Inner sleeve (480mm)	13.2
TL900047	Inner sleeve (780mm)	21.4
TL900116	Outer sleeve (380mm)	10.5
TL900042	Outer sleeve (780mm)	21.5
TL900289	Outer sleeve (1790mm)	49.4
TL900291	Outer sleeve (2515mm)	69.4

TECHNICAL PERFORMANCE

BOX PRESSURES

Rated box pressures are calculated to load cases as set out in BS EN 13331-1. The pressure is applied as an even UDL across various heights of the panel. The struts are positioned to generate worst case panel and strut loadings. In general, provided the calculated maximum applied pressure is below the rated box value, then the box is suitable. If the pressure locally peaks above the rated value, but is lower elsewhere, then panel and strut loads can be checked individually.

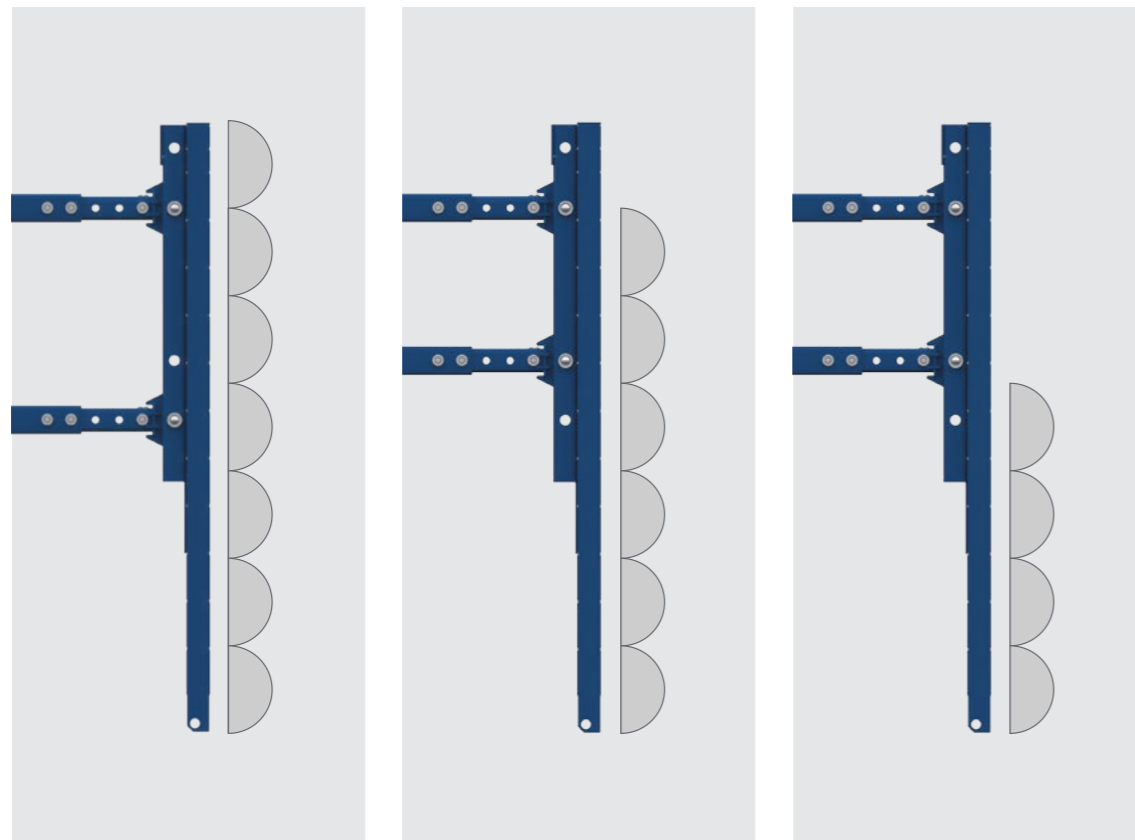

MAXIMUM LOAD ON PANEL

MAXIMUM COMPRESSION ON BOTTOM STRUT

MAXIMUM TENSION ON TOP STRUT

SWL BOX PANEL PRESSURE (kN/m ²)	SWL EXTENSION PANEL PRESSURE (kN/m ²)	SWL EXTRACTION LUG (Te)	SWL STRUT COMPRESSION (kN)	SWL STRUT TENSION (kN)
27 (Position A)	27	7.0	247.3	106.6
27 (Position B)				

TECHNICAL PERFORMANCE

BOX MOMENTS

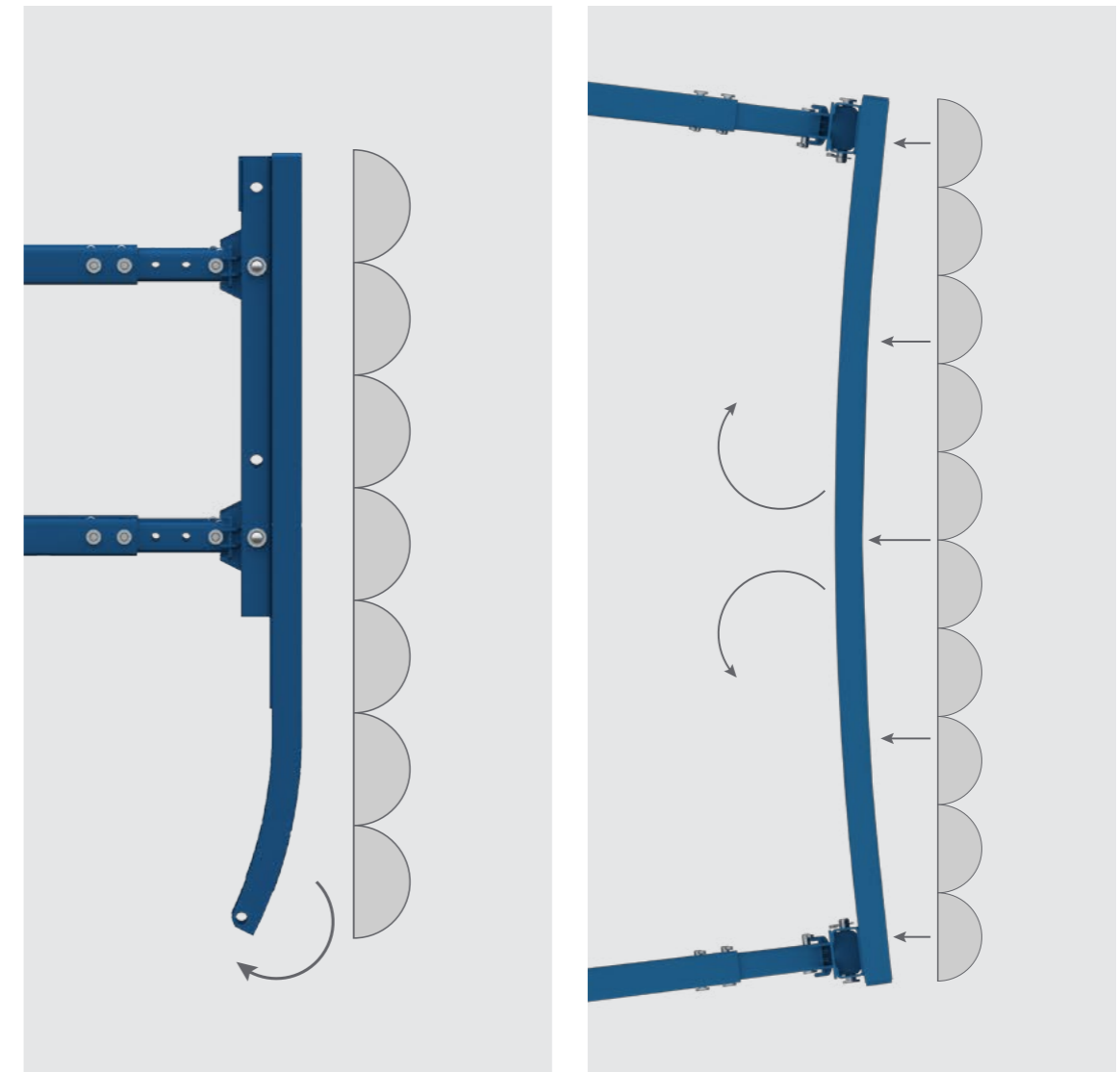

PANEL KICKING MOMENT

PANEL BOWING MOMENT

SWL PANEL KICKING MOMENT (kNm/m)	SWL PANEL BOWING MOMENT (kNm/m)
17.4	25.1

GENERAL GUIDANCE

SAFE SYSTEMS OF WORK

All aspects of handling, use and maintenance of the equipment should consider adopting a Safe System of Work. The equipment includes components with significant weight, requiring appropriate lifting plans, equipment and suitably competent operatives. Assembly of suspended loads should be managed to avoid trapping of fingers.

ACCESS

Safe access is required for assembly and use of this equipment. Further details are provided in the sections below.

STORAGE

DISASSEMBLED BOXES

Disassembled box panels should be stacked using timber packers between panels up to a maximum of 6 panels high.

Ground should be suitably flat and firm.



ASSEMBLED BOXES

Assembled boxes that are between uses or about to be used, may be stored assembled. Extensions and base boxes must be separated from each other. Base box panels must be connected by two levels of struts.

When storing, the following considerations to stability should be made:

- Ground conditions. Poor ground conditions may lead to the panel becoming unstable.
- Wind. High winds can lead to box instability.
- Width of assembly. When stored upright, narrow assemblies are inherently less stable than wider assemblies.
- Ground level. Slopes or uneven ground may contribute to a unit toppling over.

Base box units should be laid on their side on firm level ground, or upright in a temporary trench 1.0m deep.

Extension boxes should be laid on their side on firm level ground only if they are narrow (1.0m wide or less), otherwise they should be stored upright in a temporary trench 0.5m deep.

Ground should be suitably flat and firm.

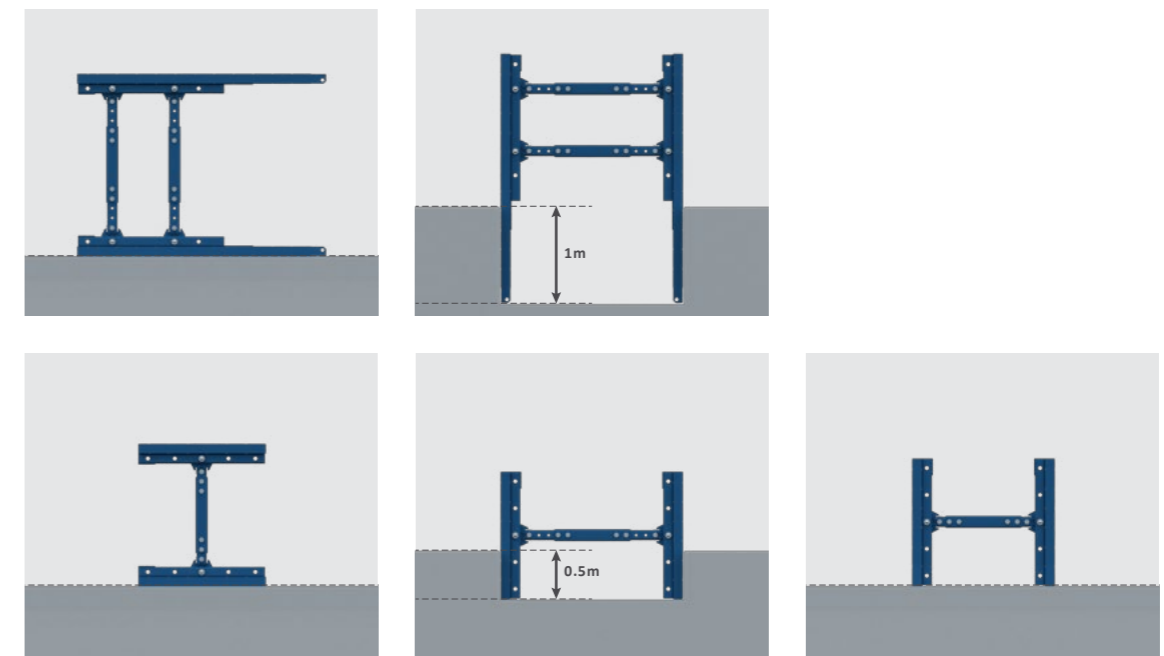

TRANSPORT & HANDLING

Ensure all panels are stacked in the same orientation and suitably restrained on the vehicle bed.

USAGE INSTRUCTIONS



- Before using this equipment, please ensure you read and understand the information outlined in the Safety section of this document.

IMPORTANT ASSEMBLY NOTES

- Top extension boxes are to be assembled in the same way but only two struts should be fitted. Extension boxes are secured to the base boxes using connector brackets and pins.
- Keep hands clear of naked surfaces.

ASSEMBLY INSTRUCTIONS

01. Before assembling Conquip base boxes and extension boxes, lay timber bearers on the ground.
02. Attach a certified 4-leg chain sling to the lifting points on one of the panels and lower onto the timber bearers.



03. Insert the rocker assemblies into the panel brackets and secure with 40mm pins and R-clips.
04. Lower the pre-assembled struts onto the rocker assemblies securing the struts to the panel brackets using pins and R-clips.

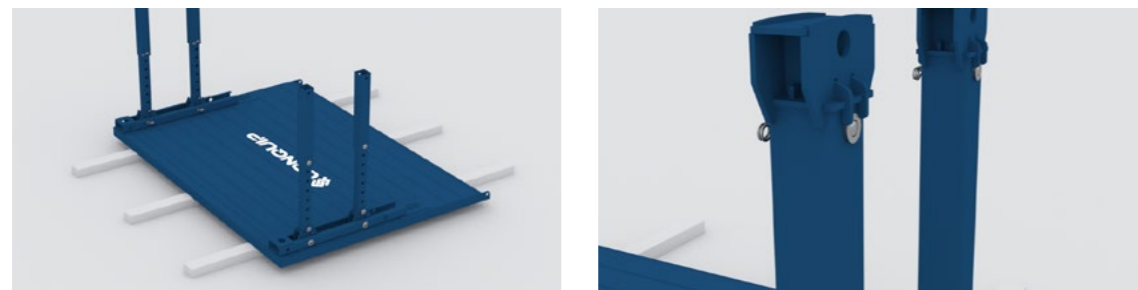

05. Connect the 4 remaining rocker assemblies to the struts using pins and R-clips.
06. Connect the sling to the lifting points of the panel facing downwards and lift into position above the struts.
07. Lower the plate carefully, guiding the runners onto the four upright strut assemblies.

DO NOT DETACH THE CHAINS UNTIL THE PANEL IS SECURED TO THE STRUT ASSEMBLIES.

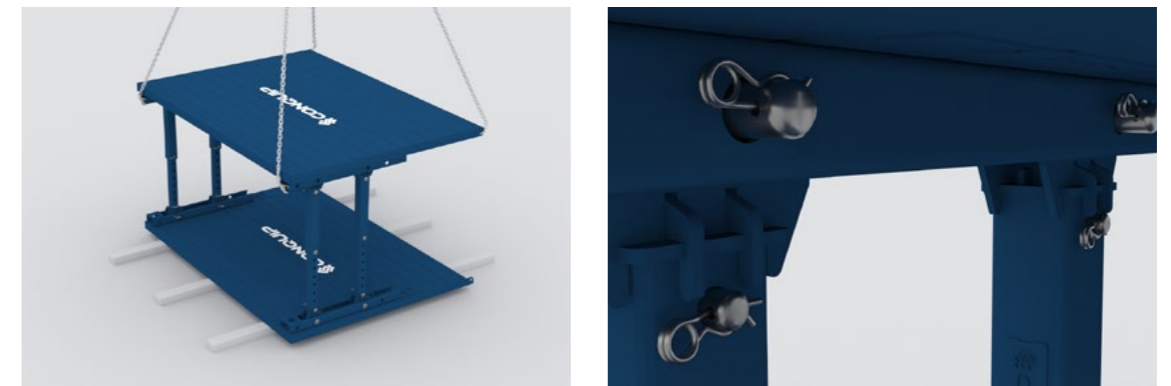

08. Secure the struts to the panel with the remaining four pins and R-clips.
09. Connect the lifting sling to the top lifting points on the Lightweight Trench Box and lift the box to the upright working position
10. The box is assembled and ready to move into the trench.

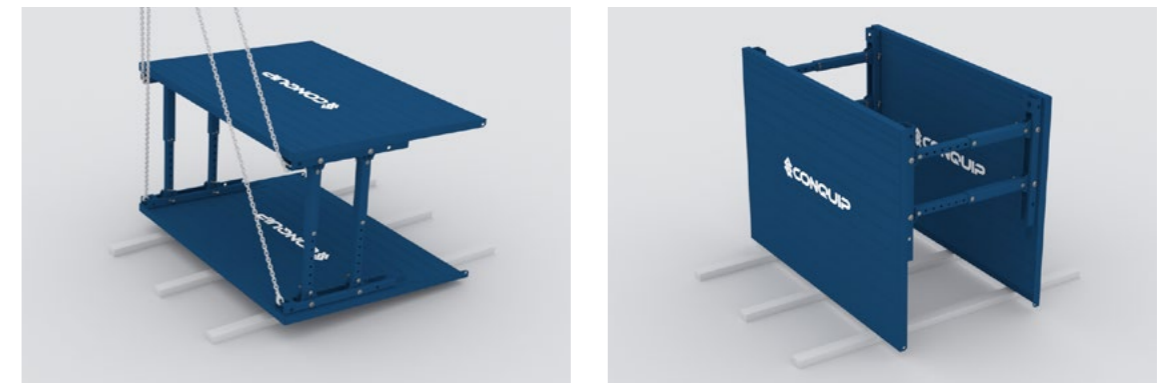



IMPORTANT INSTALLATION NOTES

In all cases you must ensure:

- All buried services and UXOs (Unexploded Ordnance) have been identified prior to works and will not be impacted by the excavation unless accounted for in the design.
- Exposed open ends of an excavation are suitably battered or closed off with End Panels.
- Gaps between the box panel and ground are filled with granular material.
- Safe Systems of Work are being worked to at all times.
- Provide safe means of access for assembly and inspection.

INSTALLATION INSTRUCTIONS

DIG AND PUSH

01. Excavate the trench to 500 to 1000mm deep (as appropriate for ground conditions). Ensure spoil is discharged away from the excavation.
02. Use a certified 4-leg chain to lower the box into the trench. Ensure the chain is long enough so that the inside chain angle does not exceed 60 degrees.
03. Backfill any over-dig at the sides of the boxes.
04. Commence a dig-and-push sequence.
 - i. Maximum 'push' should not exceed 10% of the width of the excavation
i.e. 100mm for a 1000mm wide excavation, 300mm for a 3000mm wide excavation.
 - ii. The 'push' should always be carried out on the corner of the box in sequence,
i.e. corners A → B → C → D → A

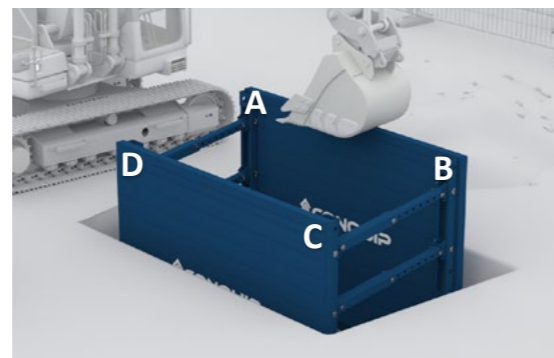
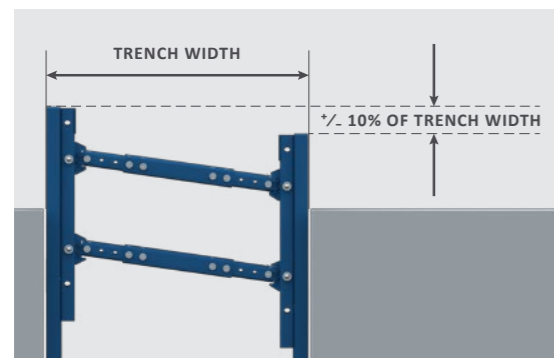
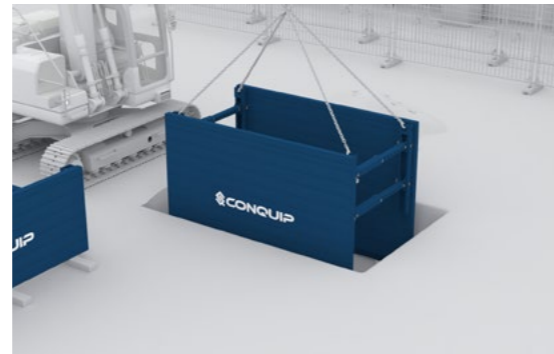

05. Continue the dig-and-push until a 950mm upstand remains.



06. To add an extension box, attach box connectors to each former and secure with 40mm pins and R-clips.



07. Lift the extension box over base unit and secure with 40mm pins and R-clips.



08. Continue excavation to required depth. Note a minimum 100mm upstand should be provided.



09. If the final panel upstand is less than 950mm, attach suitable edge protection to the side panels. After the final extension box has been attached, and dig-and-push is underway, it is recommended to attach the edge protection once the final panel is at 950mm from ground level, to ensure edge protection is maintained at all times. Take care not to impact the edge protection during final dig-and-push stages.



10. Ensure both sides of the box are level.
 11. Backfill any over-dig at the sides of the boxes.
 12. Repeat this process until the trench has been fully excavated.



USE, INSPECTION & MAINTENANCE

Prior to entering the excavation:

- Check the box and access equipment have been installed correctly. A suitably competent person should inspect the excavation from the top. Carry out air monitoring and testing as appropriate.
- Contractor must provide operatives with suitable training and briefings to safely carry out works within the excavation.
- Contractor must ensure activities surrounding the excavation are not detrimental to the integrity of the excavation (e.g. surcharges or adjacent digging that have not been considered as part of the original excavation design).
- Never move a Lightweight Trench Box whilst operatives are inside.
- Before first use and at the start of each working shift, a competent person must inspect the excavation, surrounding ground, equipment, edge protection and air quality (if required), to ensure all are satisfactory.



EXTRACTION INSTRUCTIONS

01. Ensure trench has been vacated prior to extraction of shoring boxes.
02. Carry out initial backfilling and compaction at base of excavation. Use a separating or debonding layer when concrete is used.
03. Attach certified lifting chain to the extraction point, either 2 legs on one panel, or 1 leg on one corner. Depending on the depth of box, and ground conditions, the load required to lift the box out of the ground can vary, dependant on the friction or 'stickiness' of the retained ground.
 - i. For deep excavations or excavations in poor ground it is recommended to start with lifting corners A → B → C → D → A
 - ii. For shallower excavations, or excavations in good ground it may be possible to lift a single panel side at a time A&B → C&D

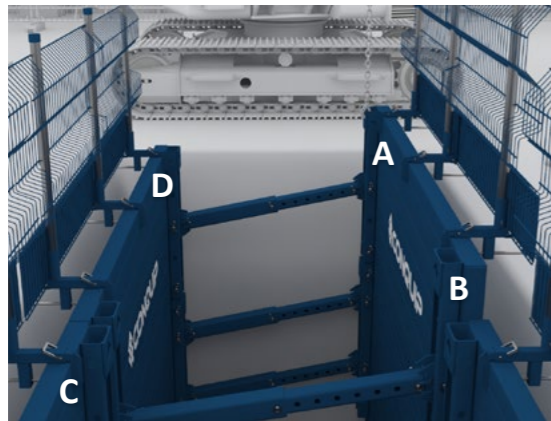

If you are having difficulties extracting the box you can:

- Excavate a 500mm deep slit trench around the perimeter of the box, replacing with loose fill. Take care not to impact the box panels.
- If the box is still not released, you can excavate in further 500mm increments, up to a total depth dependent on the ground conditions. To be assessed by a competent person on site.

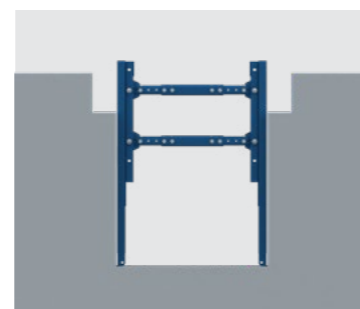

Alternatively

- For particularly difficult ground, it may be necessary to insert trench sheets down the sides of the box. Single sheets can be inserted at the corners and centre of the panel. Contact Conquip Engineering Group if you are struggling to remove the box.

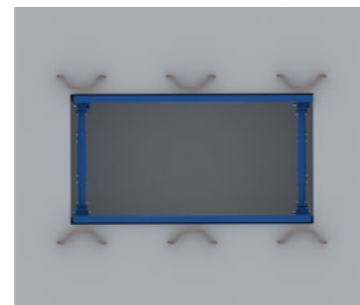

04. Continue the extraction backfilling and compacting as required at all stages.
05. Repeat until box is a minimum of 950mm above ground level and remove edge protection.
06. Continue the extraction until lower box is min 950mm above ground level. Detach the upper box and safely store. See storage section on pages 14-15.

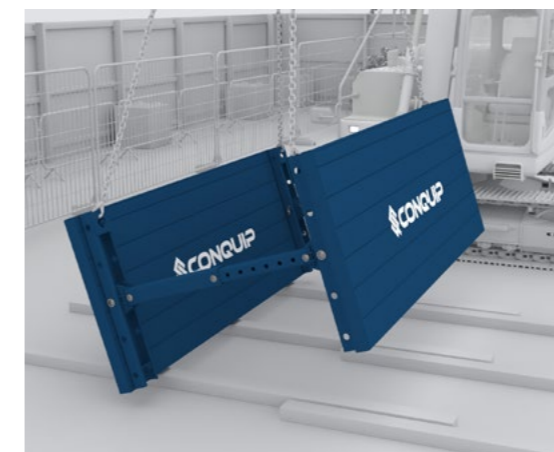
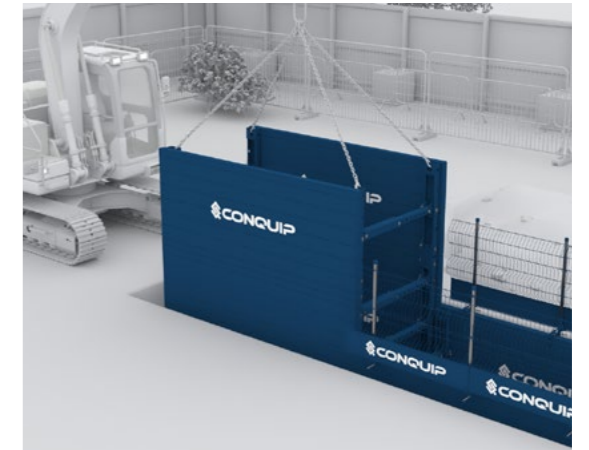
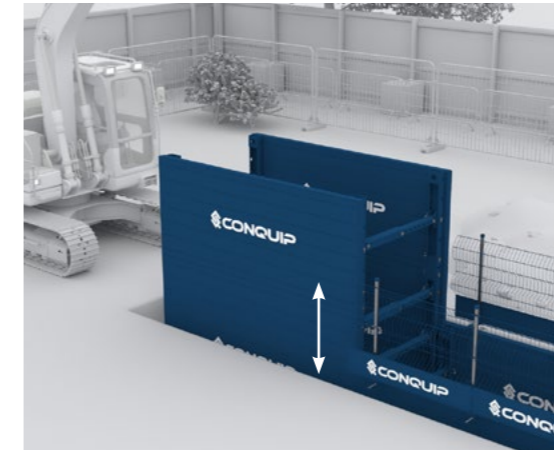

07. Remove R-clips, pins and connectors from the the base box.

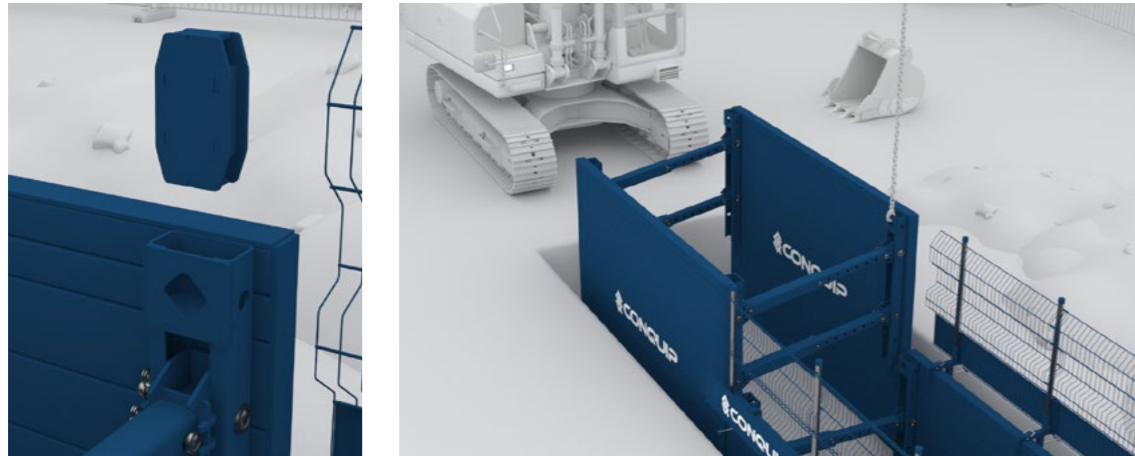

08. Continue extraction and backfill until the top of the base box is 1000mm above ground level.

09. Attach a 4-leg chain, remove the base box and safely store. See storage section on pages 14-15.

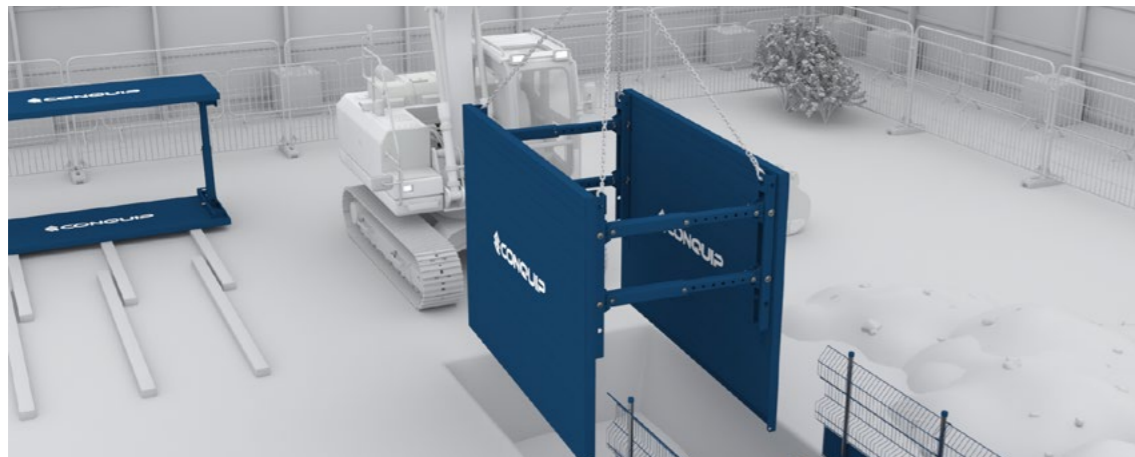

10. Fill and compact the remaining excavation.

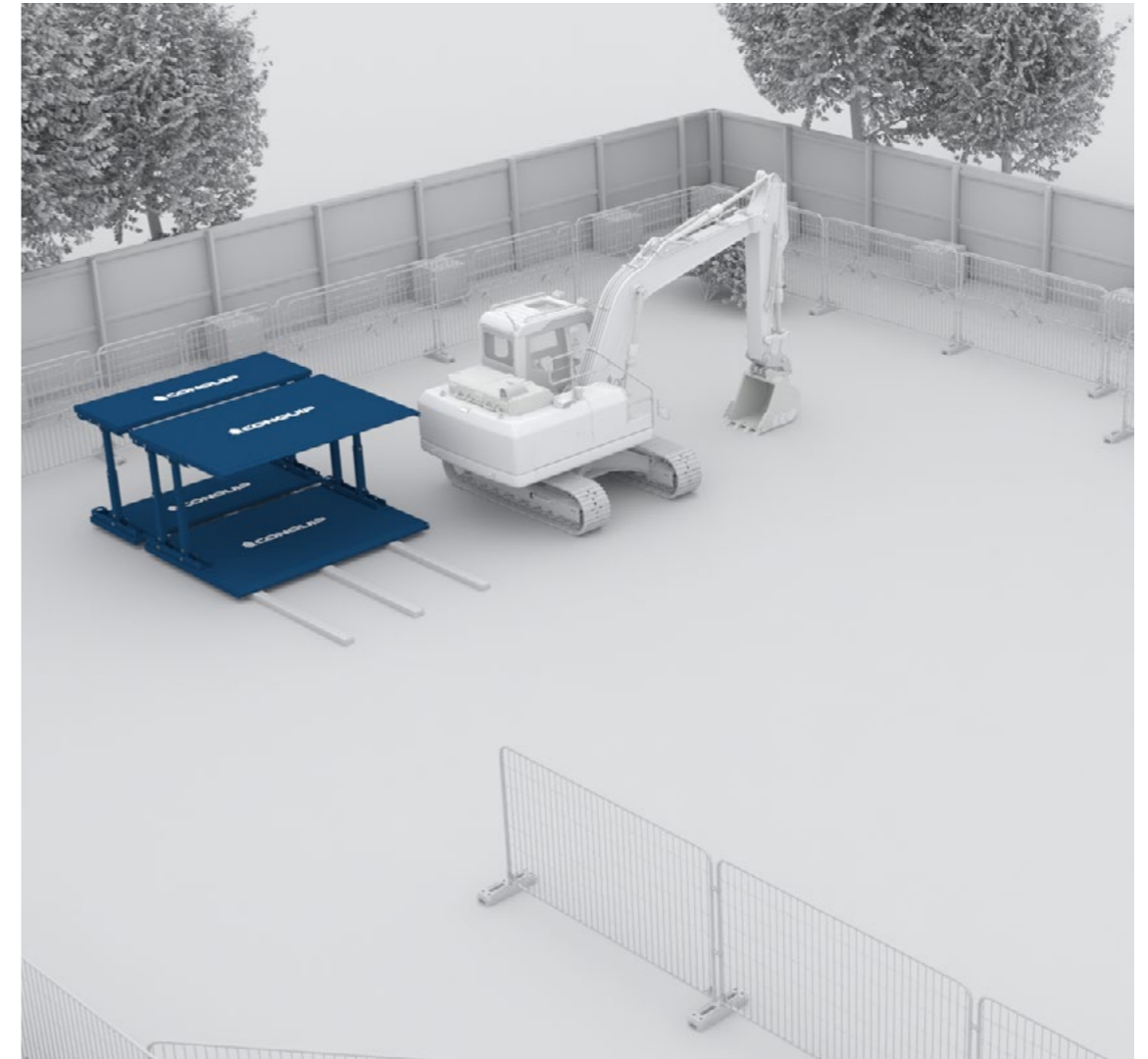

SAFETY INSTRUCTIONS

BASIC SAFETY NOTES

A site-specific risk assessment, and lift plan where applicable, must be completed by the responsible person before using this equipment to control risks, produce a safe system of work and ensure safety for you, your colleagues and others. Your risk assessment will determine the correct Personal Protective Equipment (PPE) for the task you are doing. You must use it. Conquip recommends that you should wear:

- Suitable clothing
- Gloves
- Hard hat
- Protective footwear (steel toecaps)
- Safety glasses



M002



M004



M008



M009



M010



M014

IMPORTANT SAFETY NOTES

Read these instructions before using this equipment. If there is anything you do not understand or if you have any concerns do not use this equipment. Contact your supervisor or Conquip Engineering Group for advice.

- You must check that you have considered all the safety requirements for the task you are doing and that this equipment is suitable.
- You must protect bystanders and the general public by preventing access to the working area.
- Do not use this equipment if you are tired, unwell or under the influence of alcohol or drugs. If you are taking any medicine or undergoing treatment you should inform your supervisor.

USAGE & TRANSPORTATION

- Never unevenly load this equipment.
- The weight of the equipment, together with its attachments, must be added to the weight of the load when calculating the total load that will be imposed on the lifting apparatus / operating machine.
- This equipment must be used in conjunction with the load ratings of the lifting apparatus / operating machine. (Refer to the manufacturer's load ratings and original working instructions.)
- Make sure you know how to use this equipment and understand all aspects of its operation in case of emergency.
- This equipment weighs more than 25kg. Do not lift or manhandle without machine assistance.
- Do not operate this equipment near overhead power lines.
- Take care in confined spaces, near ceilings or similar hazards. This equipment was designed for vertical lifting. Do not drag, or swing.
- Before operating this equipment, check that you have enough space for you to work safely and make sure that the working area is clear of hazards, obstructions and personnel.
- Before lowering equipment make sure that the landing zone is clear and capable of accepting the size and weight of the load.
- Crush risk. Keep hands and feet clear of the equipment at all times to avoid injury.
- Do not exceed the maximum Working Load Limit (WLL) shown on the serial plate. Ensure that the WLL on the individual lift points is not exceeded.
- Before lifting, check that the load is secured, balanced and stable. Allow space for the equipment to move if the load shifts.
- Manoeuvre loaded or raised equipment carefully. Travel and turn slowly to avoid unit becoming unstable.

PERSONNEL

- All personnel must wear relevant personal protective equipment.
- Do not wear loose clothing or jewellery and tie back long hair to avoid becoming tangled or trapped in this equipment. You must make everyone in the work area aware of what you are doing.
- All personnel involved in the lifting operation must be competent to do so and must have been briefed in conjunction with this User Guide available from Conquip Engineering Group, the manufacturer.

EQUIPMENT MAINTENANCE & CLEANING

- It is mandatory that the equipment is thoroughly examined regularly, by a qualified engineer, to ensure compliance with relevant regulation/s. (Conquip recommends to carry out a thorough examination every six months.)
- This product may incorporate various loose and detachable items of lifting gear. Refer to the separate requirements for the safe use of those items.
- This equipment must be inspected by the responsible person before each use and then regularly, as determined by your risk assessment or working practice. If you have any concerns about condition or suitability do not use.

DO'S AND DON'TS

DO:

- ✓ Contact Conquip Engineering Group if you are unsure.
- ✓ Inspect all components prior to first use and each shift thereafter.
- ✓ Use suitable lifting equipment at all times.
- ✓ Ensure the surrounding ground profile and all possible surcharges have been included in the design information when selecting a box. Slopes near an excavation can increase the loads on the box.
- ✓ Maintain edge protection on all leading edges.
- ✓ Ensure all operatives using the equipment and excavation are fully briefed with a Safe System of Work and appropriate supervision.
- ✓ Obtain a bespoke design where one is required for the specific ground conditions or use case. (Conquip can provide this service.)
- ✓ Ensure all pins and clips are fully engaged and secured.
- ✓ Be vigilant for catching fingers.
- ✓ Identify all buried services prior to excavation.
- ✓ Keep operatives clear of active slewing operations.

DON'T:

- ✗ Use the struts to support trench sheets, unless permitted by a bespoke design.
- ✗ Use more than two extension boxes unless permitted by a bespoke design.
- ✗ Fly the boxes above excavation formation level unless permitted by a bespoke design.
- ✗ Have out-of-balance excavations at the sides. Fill with loose material.
- ✗ Enter the box during installation.
- ✗ Drag the box.
- ✗ 'Snatch' the lifting chains when extracting the box from the ground.
- ✗ Enter a 'confined space' without suitable air monitoring equipment. Trench excavations may be considered as a 'confined space'

BOX POSITIONING:

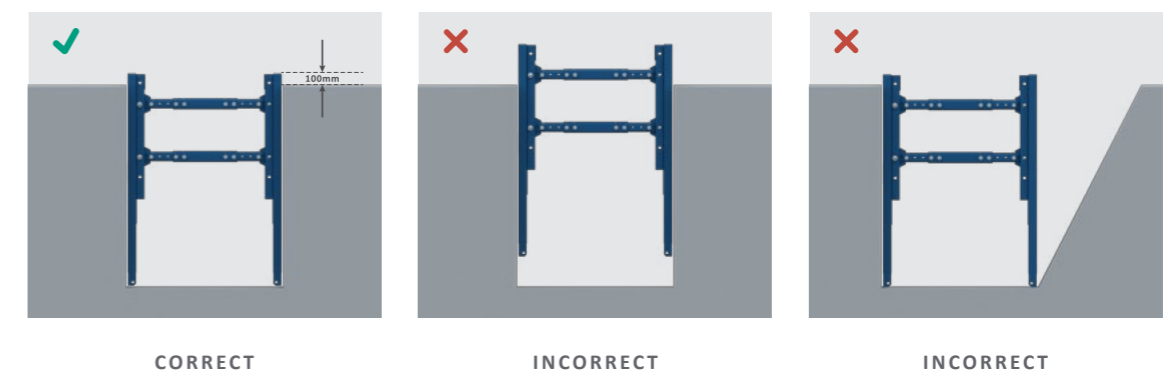

TERMS & CONDITIONS

CONQUIP ENGINEERING GROUP STANDARD PRODUCT WARRANTY

01. COMMENCEMENT

1.1 This Warranty shall commence on the Commencement Date and shall continue until the earlier of:

- (a) the Expiry Date; or
- (b) the date on which it may be voided in accordance with clause 4.1(b)

when it shall terminate automatically without notice.

02. DUTY OF GOOD FAITH

2.1 The Purchaser shall in the exercise of its rights under this Warranty and in the compliance with its obligations under this Warranty be subject to and shall in all respects owe and comply with a duty of good faith to the Warrantor.

03. NATURE AND EXTENT OF COVER

3.1 Subject to clause 3.2 the Warrantor agrees and undertakes to the Purchaser that it shall be liable to the Purchaser under and in accordance with the terms of this Warranty in the event that:

- (a) prior to the Expiry Date the Purchaser shall notify a Warranty Claim to the Warrantor; and
- (b) the Equipment or any relevant part of the Equipment shall have become unusable as the result of defective material or defective workmanship prior to the Expiry Date.

3.2 The Warrantor's obligation under clause 3.1 shall be expressly subject to the provisions of clauses 4, 5 and 6 and conditional upon the Purchaser's compliance in full with the provisions of clause 7.

04. RESTRICTIONS

4.1 The following restrictions apply to this Warranty:

- (a) This Warranty is personal to the Purchaser and neither the legal benefit nor legal burden of this warranty may be assigned or novated or otherwise transferred by the

Purchaser to any other party. Any purported assignment, novation or transfer shall not be binding upon the Warrantor.

(b) This Warranty shall be void in the event that the Purchaser:

- (i) cannot provide authentic and original documentary evidence that the Purchaser has during the period between the Commencement Date and the Expiry Date complied with the Maintenance and Servicing Requirements; and/or
- (ii) has, during the period between the Commencement Date and the Expiry Date, exceeded the Purchaser's Usage Cycle Parameters; and/or
- (iii) has, during the period between the Commencement Date and the Expiry Date, exceeded the Purchaser's Use Parameters; and/or
- (iv) has carried out, or procured the carrying out by any third party of, any repair to the Equipment or any part of the Equipment which is not an Authorised Repair; and/or
- (v) has operated the Equipment after having replaced any part of the Equipment with a part which has not been supplied and fitted by the Warrantor; and/or
- (vi) has modified the Equipment in any way prior to use.

05. EXCLUSIONS

5.1 The following are excluded from the scope of this Warranty:

- (a) Loss of and/ or damage to the Equipment or any part of it resulting from any collision between the Equipment and any other fixed or stationary or mobile object whatsoever, irrespective of whether that collision was or was not caused by the Purchaser; and/or
- (b) Loss of and/or damage to any personal property and/or possessions or other equipment not forming part of the Equipment but which is present in or about the Equipment; and/or
- (c) loss and/or damage which is covered by any other insurance policy taken out and maintained by the Purchaser or in respect of which the Purchaser has a contractual obligation to do so; and/or
- (d) loss and/or damage to the equipment which is consistent with the use by the Purchaser of the Equipment:
 - (i) in compliance with the Maintenance and Servicing Requirements; and
 - (ii) in compliance with the Usage Cycle Parameters; and
 - (iii) in compliance with the Use Parameters; and
 - (iv) having only carried out Authorised Repairs to the Equipment; and
 - (v) having all and any replacement parts fitted by the Warrantor; and

(vi) in unmodified form.

06. LIMITATION OF LIABILITY

6.1 The Warrantor's liability to the Purchaser shall be limited as follows:

(a) The Warrantor shall not in any circumstances be liable to the Purchaser for indirect and/or consequential and/or economic loss suffered and/or incurred as the case may be by the Purchaser; and

(b) The Warrantor shall only be liable to the Purchaser for the reasonable and proper costs reasonably and properly incurred by the Purchaser directly in connection with the repair and/or replacement (at the Warrantor's absolute discretion) of the Equipment or any part of the Equipment; and

(c) The Warrantor's liability to the Purchaser shall notwithstanding any other provision of this Warranty, not in any circumstances exceed the Purchase Price of the Equipment.

07. WARRANTY CLAIMS

7.1 The Purchaser shall in respect of any claim against the Warrantor under this Warranty and within 24 hours of the occurrence of the subject matter of the Warranty Claim:

(a) Complete in full and submit to the Warrantor a Warranty Claim in the form annexed to Schedule 4;

(b) Provide date stamped or date identifiable photographs evidencing the claim; and

(c) Make the Equipment or the relevant part of the Equipment available to the Warrantor for inspection within 48 hours of notification of the relevant Warranty Claim.

08. ENTIRE AGREEMENT

8.1 This Warranty constitutes the entire agreement between the parties and supersedes and extinguishes all previous promises, assurances, warranties, representations and understandings between them, whether written or oral, relating to its subject matter.

8.2 Each party agrees that it shall have no remedies in respect of any statement, representation, assurance or warranty (whether made innocently or negligently) that is not set out in this Warranty. Each party agrees that it shall have no claim for innocent or negligent misrepresentation or negligent misstatement based on any statement in this Warranty.

No variation of this Warranty shall be effective unless it is in writing and signed by the parties (or their authorised representatives).

09. WAIVER

No failure or delay by a party to exercise any right or remedy provided under this Warranty or by law shall constitute a waiver of that or any other right or remedy, nor shall it prevent or restrict the further exercise of that or any other right or remedy. No single or partial exercise of such right or remedy shall prevent or restrict the further exercise of that or any other right or remedy.

10. SEVERANCE

10.1 If any provision or part-provision of this Warranty is or becomes invalid, illegal or unenforceable, it shall be deemed deleted, but that shall not affect the validity and enforceability of the rest of this Warranty.

10.2 If any provision or part-provision of this Warranty is deemed deleted under clause 10.1 the parties shall negotiate in good faith to agree a replacement provision that, to the greatest extent possible, achieves the intended commercial result of the original provision.

11. THIRD PARTY RIGHTS

11.1 This Warranty does not give rise to any rights under the Contracts (Rights of Third Parties) Act 1999 to enforce any term of this Warranty.

12. GOVERNING LAW

12.1 This Warranty and any dispute or claim (including non-contractual disputes or claims) arising out of or in connection with it or its subject matter or formation shall be governed by and construed in accordance with the law of England and Wales.

13. JURISDICTION

13.1 Each party irrevocably agrees that the courts of England and Wales shall have exclusive jurisdiction to settle any dispute or claim (including non-contractual disputes or claims) arising out of or in connection with this Warranty or its subject matter or formation.

EC DECLARATION OF CONFORMITY

IN ACCORDANCE WITH ISO/IEC 17050-1:2004

Declaration: As defined by the Machinery Directive 2006/42/EC and subsequent amendments

We, CONQUIP ENGINEERING GROUP, herewith declare that the following indicated equipment meets the fundamental health and safety requirements concerning the ISO/IEC 17050-1:2004 guideline(s), due to their design and manufacture.

This declaration will be rendered null and void if the machine is changed without our approval.

SIGNED:



DATED: 2023

Garry Critchley, Managing Director

PRODUCT CODES	GENERAL DESCRIPTION / DESIGNATION:	WORKING LOAD LIMIT:
TL102-00003	Lightweight Trench Box 3000 Base	27 kPa
TL102-00004	Lightweight Trench Box 3000 Extension	27 kPa

ITEM	CODE	DESCRIPTION
EC DIRECTIVE/REGULATION:	2006/42/EC	Directive 2006/42/EC- new machinery directive
HARMONISED STANDARDS:	BS EN 13331-1:2002 BS EN 13331-2:2002	Trench Lining Systems
	BS EN 12811-2:2004	TW Equipment- Information on materials
	BS EN 1993-1-1 2005	Eurocode 3. Design of steel structures General rules and rules for buildings
	BS EN 1990:2002+A1:2005	Eurocode. Basis of structural design
OTHER REGULATIONS:	LOLER 1998	Lifting Operations and Lifting Equipment Regulations 1998 (LOLER)
	PUWER 1998	Provision and Use of Work Equipment Regulations 1998 (PUWER)

TALKING TO US IS EASY
WE'RE HERE TO HELP

Call us on 0333 300 3470
Email us at sales@cqegroup.com
www.cqegroup.com

