

User Guide

Pod Lifting Frame



Product Information

Overview

The Conquip Pod Lifting Frame is used in situations where the use of a CantiDeck is not feasible. It enables prefabricated modular pods to be transported into a building structure.

Integrated attachment points on the floor of the frame ensure the pod can be safely secured and lifting points in each corner allow for quick and easy attachment. Once lifted to the desired level, the frame can be secured using the attachment points on the beams and anchor points within the building.

The ramp sits on the slab edge which allows the pod to be smoothly and easily transferred from the Pod Lifting Frame into the building.

Key Benefits

- The frame incorporates integrated attachment points to secure the pod in the frame and to secure the frame to the building structure.
- The frame doors lock into place as an extra safety precaution.
- It comes equipped with 4 lifting points that provide greater stability during lifts and allow for quick and easy connection to a 4 leg chain.
- Manufactured in the UK from quality British and EU steel.

Product Information

Specification

Item	Product Code
Pod Lifting Frame	CA144AB-03000

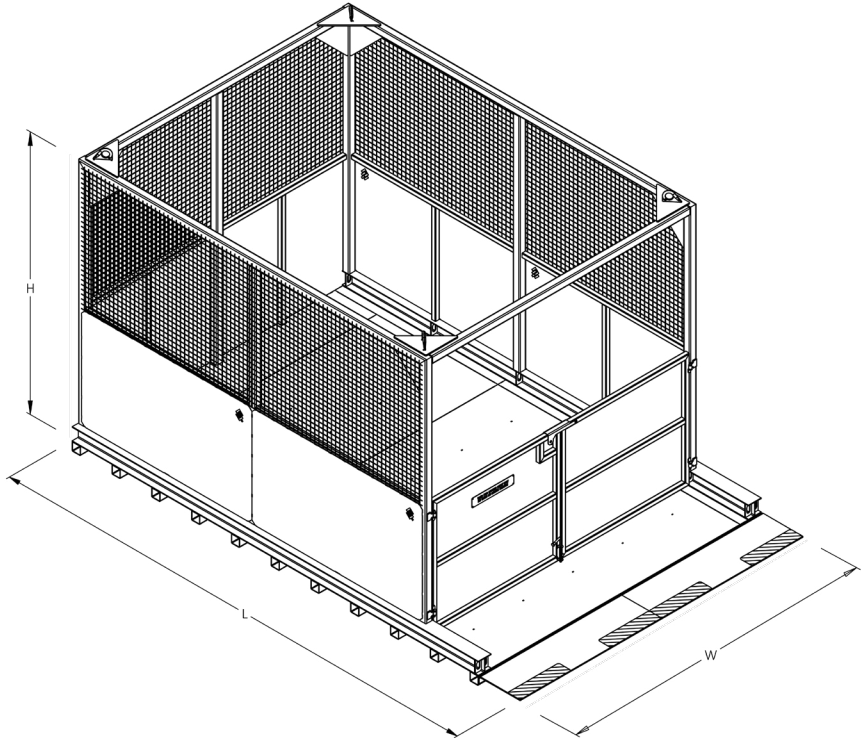

¹Working Load Limit

Height	Width	Length	Weight	WLL ¹
3100mm	3385mm	5360mm	2250kg	3000kg

Product Information

Specification

Item	Product Code
Pod Lifting Frame	CA144AB-03000

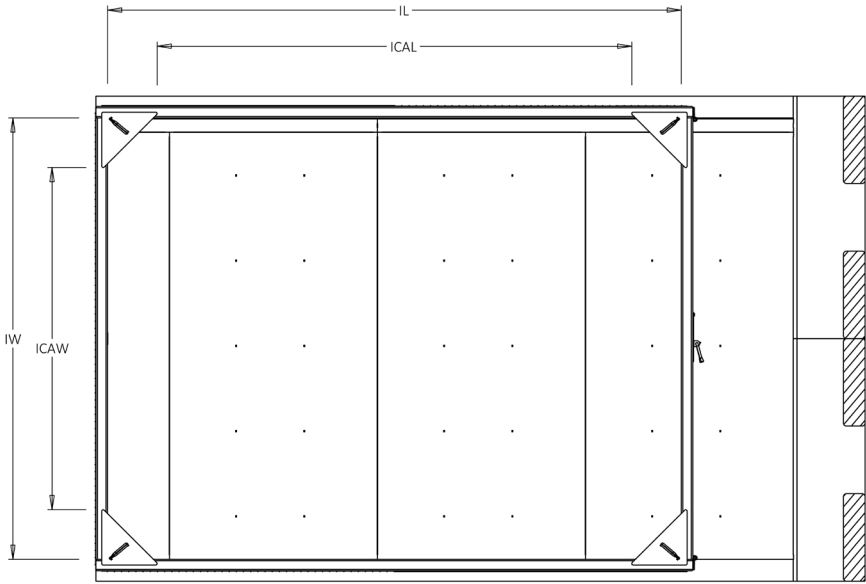

Internal Height	Internal Length	Internal Clear Area Length	Internal Width	Internal Clear Area Width
2800mm	4060mm	3300mm	3140mm	2380mm

Product Information

Parts Diagram

Pod Lifting Frame

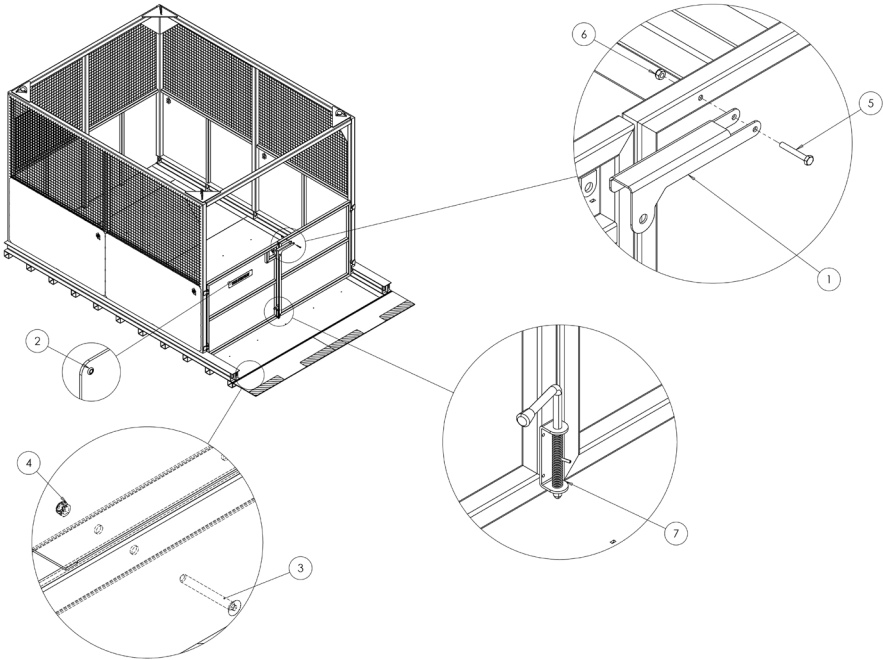

NOTE: These parts are for this model, they may differ for previous versions. Please contact Conquip with any queries.

Item Number	Part Number	Description	Quantity
1	ZZ190064	Gate Latch	1
2	4.8mm Pop Rivet	4.8mm Pop Rivet	4
3	NS800885	M16 x 140 Socket Countersunk Head Screw	8
4	NS800121	M16 Nyloc Nut	8
5	M10 x 70 Hex Head Bolt	M10 x 70 Hex Head Bolt	1
6	NS800013	M10 Nyloc Nut	1
7	ZZ990422	Spring Bolt	1

Original Working Instructions

Usage Instructions

Important Usage Notes

- The Pod Lifting Frame must only be lifted by the designated four lifting points.
- The Pod Lifting Frame is for lifting and transporting pods only. DO NOT use to raise or transport personnel.

Usage Instructions

1. Create an exclusion zone at ground level.

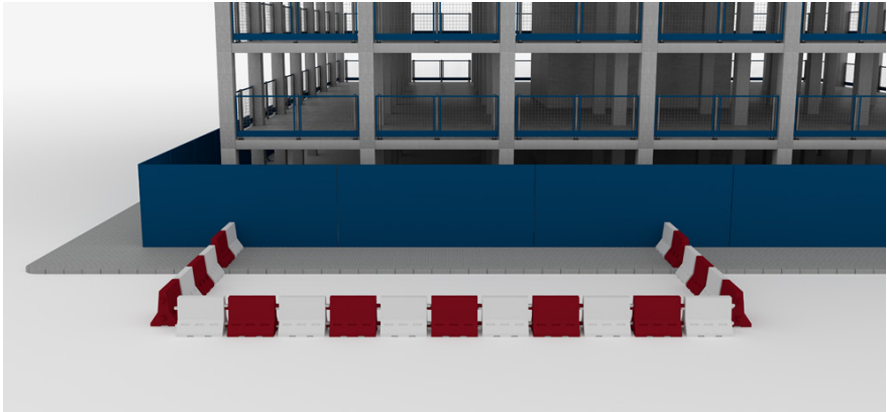

2. Then create an exclusion zone within the building prior to lifting.

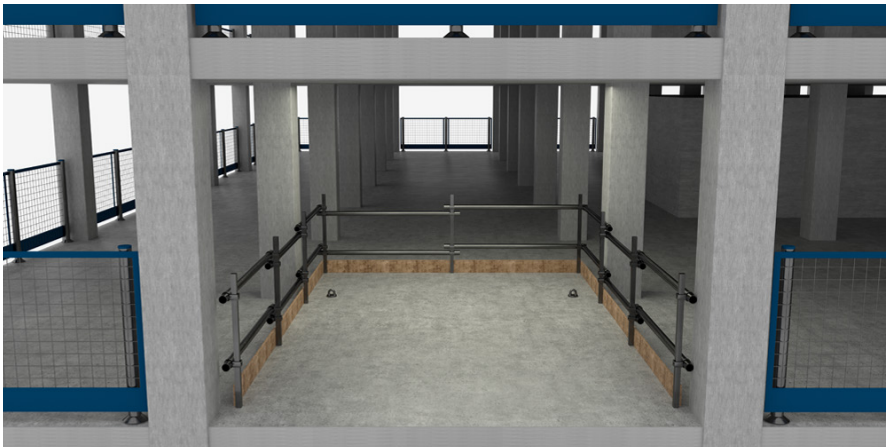

Original Working Instructions

Usage Instructions

3. Attach a suitable rated chain sling that will withstand the weight of the pod and the Pod Lifting Frame.

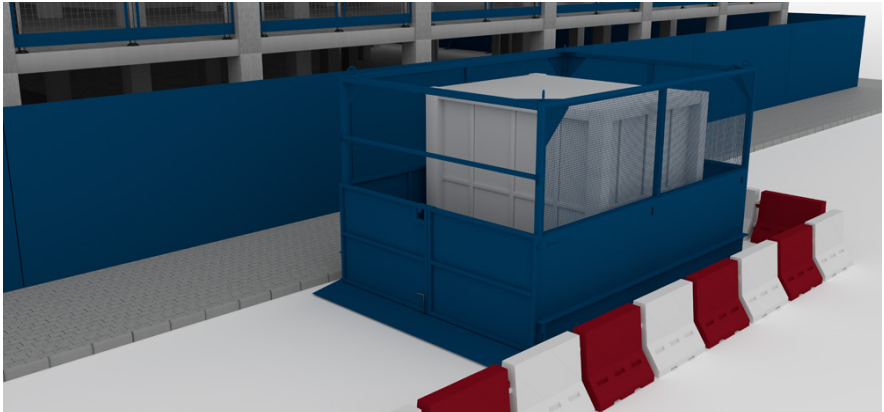

4. Check the dimensions of the pod against the internal dimensions of the Pod Lifting Frame prior to loading.
5. Load the Pod Lifting Frame with the pod using the access doors. If loading from above, the internal dimensions will reduce. Please refer to the 'Clear Area' dimensions in the specification drawing on page 4.

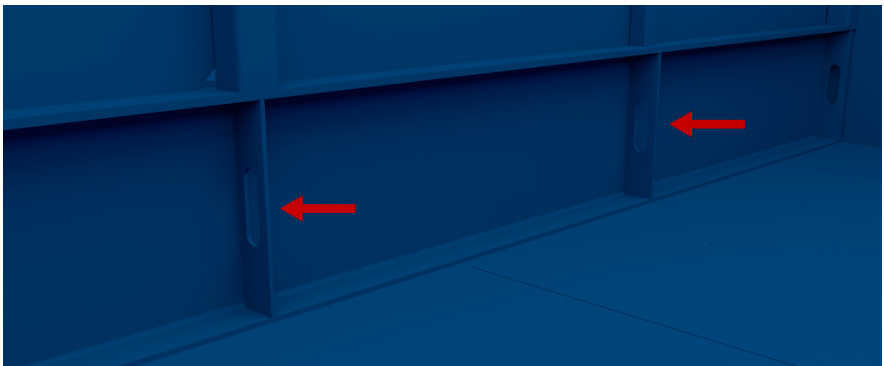

6. Secure the load, using the integrated attachment points.
7. Ensure the doors are fully closed and the pin is in the locked position before lifting.
8. Once the supervisor is happy that the load is secure, balanced, and does not

Original Working Instructions

Usage Instructions

exceed maximum loading weights, attach a suitable rated chain sling to the end of the four lifting single lifting chains at each of the corners of the frame.

9. Check that personnel are clear from the immediate area and the future location to allow for swing of the frame when lifting off the ground.
10. Ensure tag lines are attached to the Pod Lifting Frame.
11. Carefully raise the frame just off the ground and check for balance and security.

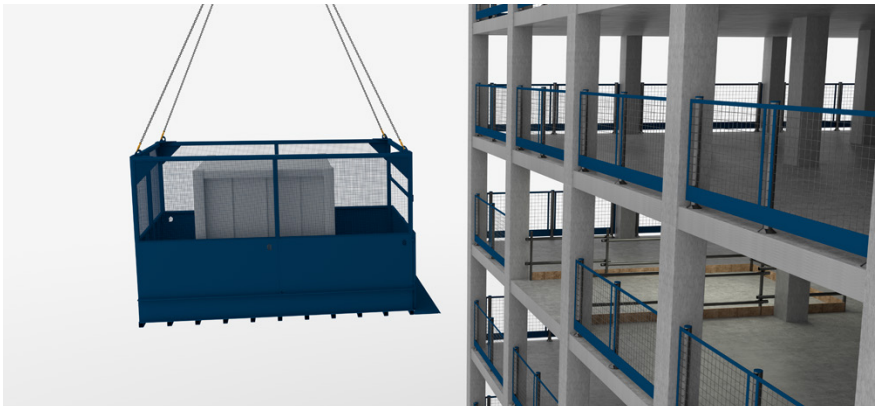

12. Crane lift the frame to the required level of the building or structure.
13. Guide into place using the tag lines and lower until the ramp is resting on top of the slab edge and the frame is flush to the building.



Original Working Instructions

Usage Instructions

14. Secure the frame to the building by fastening ratchet straps to the integrated attachment points on the Pod Lifting Frame and designated anchor points in the building.



15. Before unloading the pod, consider risk assessment and ensure necessary safety steps have been taken to allow personnel to access a suspended load.
16. Keep the crane fixed during offload.
17. Once the Pod Lifting Frame is secure, open the doors and unload the pod from the frame.

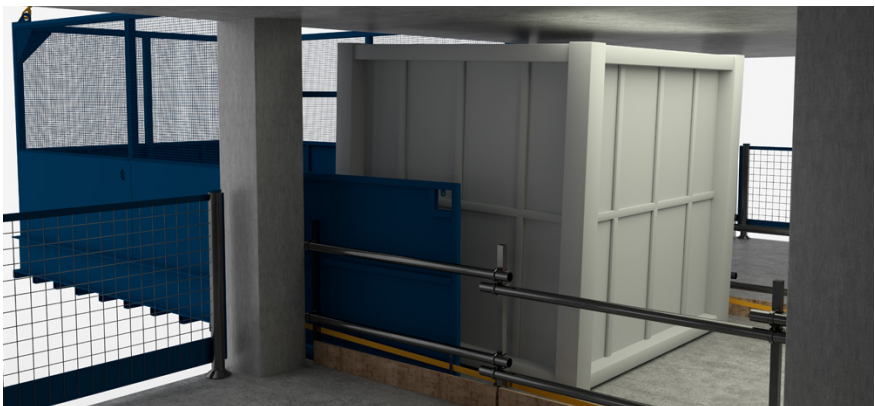

Original Working Instructions

Usage Instructions

18. After the pod has been unloaded and all personnel are clear of the Pod Lifting Frame, unhook the ratchet straps to release it from the building and replace the edge protection on the building's edge.

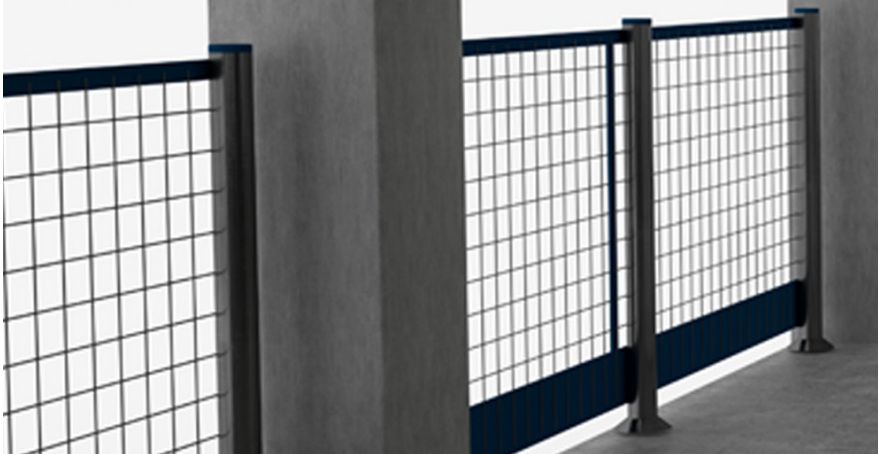

19. Lower the Pod Lifting Frame onto a firm, stable, flat surface.
20. Once you have finished using the Pod Lifting Frame, detach it from the lifting equipment.

Original Working Instructions

Safety Instructions

Basic Safety

A site-specific Risk Assessment, and lift plan where applicable, must be completed by the responsible person before using this equipment to control risks, produce a safe system of work and ensure safety for you, your colleagues and others. Your risk assessment will determine the correct Personal Protective Equipment (PPE) for the task you are doing. You must use it. Conquip recommends that you should wear:

- Suitable clothing
- Gloves
- Hard hat
- Protective footwear (steel toecaps)
- Safety glasses



Important Safety Notes

- Read these instructions before using this equipment. If there is anything you do not understand or if you have any concerns do not use this equipment. Contact your supervisor or Conquip Engineering Group for advice.
- You must check that you have considered all the safety requirements for the task you are doing and that this equipment is suitable.
- You must protect bystanders and the general public by preventing access to the working area.
- Do not use this equipment if you are tired, unwell or under the influence of alcohol or drugs. If you are taking any medicine or undergoing treatment you should inform your supervisor.

Usage & Transportation

- Never unevenly load this equipment.
- The weight of the equipment, together with its attachments, must be added to the weight of the load when calculating the total load that will be imposed on the lifting apparatus / operating machine.
- This equipment must be used in conjunction with the load ratings of the lifting apparatus / operating machine. (Refer to the manufacturers' load ratings and original working instructions).
- Make sure you know how to use this equipment and understand all aspects of its operation in case of emergency.
- This equipment weighs more than 25kg. Do not lift or manhandle without machine assistance.
- Do not operate this equipment near overhead power lines.
- Take care in confined spaces, near ceilings or similar hazards. This equipment was designed for vertical lifting. Do not drag, or swing.
- Before operating this equipment, check that you have enough space for you to work safely and make sure that the working area is clear of hazards, obstructions and personnel.
- Before lowering equipment make sure that the landing zone is clear and capable of accepting the size and weight of the load.
- Crush Risk. Keep hands and feet clear of the equipment at all times to avoid injury.
- Do not exceed the maximum Working Load Limit (WLL) shown on the serial plate. Ensure that the WLL on the individual lift points is not exceeded.
- Before lifting, check that the load is secured, balanced and stable. Allow space for the equipment to move if the load shifts.

Personnel

- All personnel must wear relevant personal protective equipment.
- Do not wear loose clothing or jewellery and tie back long hair to avoid becoming tangled or trapped in this equipment. You must make everyone in the work area aware of what you are doing.
- All personnel involved in the lifting operation must be competent to do so and must have been briefed in conjunction with this User Guide available from Conquip Engineering Group, the manufacturer.

Equipment Maintenance & Cleaning

- It is mandatory that the equipment is thoroughly examined regularly, by a qualified engineer, to ensure compliance with relevant regulation/s. (Conquip recommend to carry out thorough examination every six months).
- This product may incorporate various loose and detachable items of lifting gear. Refer to the separate requirements for the safe use of those items.
- When not being used, store the unit in a clean, upright condition and in a safe place where it will be protected from thieves and unauthorised users.
- This equipment must be inspected by the responsible person before each use and then regularly, as determined by your risk assessment or working practice. If you have any concerns about condition or suitability do not use.

Disclaimer

Warranty

The products supplied by Conquip Engineering Group are all guaranteed by a 12 month warranty.

Apart from where exceptions apply, Conquip Engineering Group promises to repair or replace any fault which the Company considers to be due to defective material or workmanship within 12 months of the date of sale, at no additional cost.

- Faults arising from unauthorised alterations (see modifications section below for full details).
- Damage caused by abuse, neglect, misuse or falling.
- Damage caused because of failure to follow transportation, storage, loading, cleaning or operating instructions.
- Replacement or repair of components due to fair wear and tear.
- Any consequential damage or wear arising from the use or fitting of additional or non-standard parts.

Modifications

If any third-party modifications or alterations, involving drilling, welding, cutting or distortion of materials in any form, are to be carried out on the product, Conquip Engineering Group must provide full written approval prior to the work being carried out.

Alterations, modifications, additions or repairs must be carried out by Conquip Engineering Group's recognised distributors, if they are not carrying out the work themselves.

Conquip Engineering Group operate a continuous improvement policy and therefore reserve the right to alter technical specifications and user guide details at any point without notice.

Conquip Engineering Group will not cover or reimburse any transportation and/or shipment costs to and from their premises or their recognised agents, or any material and/or labour costs for repair, replacement or assessment against a warranty claim.

Conquip Engineering Group and/or their directors, employees, insurers or recognised agents will not be held liable for consequential damages, losses or expenses relating to the inability to use the product correctly for its purpose.

Important Notes

- This User Guide is for this Conquip product only.
- Any movements of the product must be thoroughly planned before the work commences to identify potential hazards and assess risk.
- All personnel involved in lifting and transportation of this product must have read this User Guide and must be properly briefed.
- You must be competent, alert and medically fit when using this equipment. If you have a medical condition, a mental or physical disability, you must seek advice from a medical professional before using this equipment.

Talking to us is easy

We're here to help

Call us on 0800 116 076

Email us at sales@conquipgroup.co.nz

www.conquipgroup.co.nz